

QUARTZ TIME RECORDER

QR-395

USER'S MANUAL

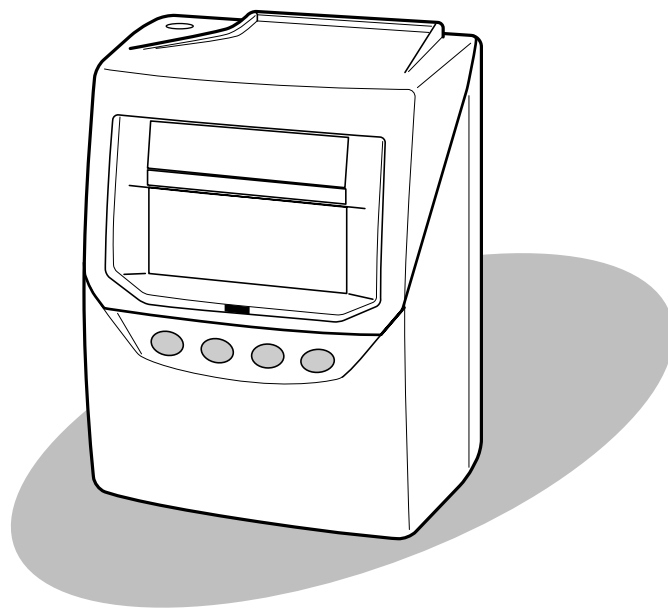

SEIKO Precision

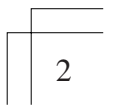
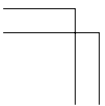
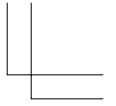
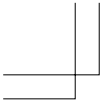

INTRODUCTION

Thank you for purchasing our Quartz Time Recorder. For safe and proper operation, please carefully read this manual before using it and save it for reference.

Bescheinigung des Herstellers/Importeurs

Dies Gerät entspricht den Bedingungen der Niederspannungs-Vorschrift 2006/95/EC und dem EMVG nach 2004/108/EC.

This unit complies with the Low Voltage Directive 2006/95/EC and the EMC Directive 2004/108/EC.

Maschinenlärminformations-Verordnung 3. GPSGV:

Der höchste Schalldruckpegel beträgt 70 dB (A) oder weniger gemäss EN ISO 7779.

Die zugehörige Steckdose muß nahe beim Gerät angebracht und leicht zugänglich sein.

1. The details of this Operation Manual are subject to change without previous notification.
2. This Operation Manual has been prepared with the utmost care to cover all aspects of the time recorder's use.
If you feel, however, that some explanations are inadequate, unclear, or difficult to understand, please do not hesitate to contact the dealer or the shop from which you have purchased your Time Recorder.
3. Be sure to use your Time Recorder after you have fully understood the hardware and software specifications and limits.
4. No part of this publication may be reproduced, stored in a retrieval system, or transmitted, in any form or by any means, mechanical, photocopying, recording or otherwise.
 - Place the time recorder at the position close to the wall outlet so that it is easily accessible to disconnect.

Die in dieser Bedienungsanleitung enthaltenen Angaben können jederzeit ohne vorherige Ankündigung geändert werden.

Diese Bedienungsanleitung wurde mit äußerster Sorgfalt erstellt, um alle Einzelheiten hinsichtlich der Bedienung des Zeiterfassungsgerätes darzustellen. Sollten Sie dennoch Fragen haben oder Fehler in der Anleitung entdecken, nehmen Sie bitte mit uns Kontakt auf.

Wir haften nicht für direkte oder indirekte Schäden, die durch die Verwendung dieser Betriebsanleitung entstehen.

Lesen Sie diese Anleitung aufmerksam und benutzen Sie Ihr Zeiterfassungsgerät erst dann, wenn Sie die Angaben über die Hardware und Software richtig verstanden haben.

TABLE OF CONTENTS



1. PRECAUTIONS	1
2. FEATURES	3
3. GETTING STARTED	4
Accessories / Features	4
Installing the Ribbon Cassette	5
Installing the Unit / Mounting Unit on Wall	7
Environmental Conditions	7
4. DAILY OPERATIONS	9
Default Setting	10
5. BASIC SETTINGS	11
Preparation for Setting	11
Selecting Display Hours	12
Setting the Time	13
Setting the Date	14
Setting the Day Advance Time	15
Selecting the Card Type and Pay Period / Setting the Card Type and Pay Period	16
Setting the Daylight Saving Time / Deleting the Daylight Saving Settings	20
Selecting the Print Format	24
6. ADVANCED SETTINGS	26
Schedule	26
Setting the Schedule (Common Schedule / Extra Schedule / Max in Value)	28
Special Mark Printing / Setting the Special Mark Printing	35
Program List for Setting Schedules	36
Rounding / Setting the Rounding	37
Weekly Program / Setting the Weekly Program	39
Setting the Password / How to Change Settings When the Password Is Set /Cancelling the Password	44
7. ADDITIONAL FUNCTIONS	47
Resetting	47
Card Reassign	48
All Cards Reset / Card Reset	49
Printing List of Setting Information and Active Cards	51
8. INSTALLING THE BATTERY (OPTIONAL)	52
9. TROUBLESHOOTING	53
10. SPECIFICATIONS	55
11. TIME CARD SPECIFICATIONS	56





1. PRECAUTIONS







This operation manual is prepared for safe and proper use of the unit. Please follow all the instructions to avoid possible danger to yourself or others and damage to the unit.



Signs

Various warnings and cautions are provided throughout this manual along with signs. Remember each sign and its explanation listed below for your safety and proper operation of the unit.











 Warning	Improper handling may cause bodily accidents including death and serious injury.
 Caution	Improper handling may harm the human body or material.

 Improper handling may cause electric shock DANGER.	 "Must-Do" sign.
 DO NOT disassemble the unit.	 Be sure to remove the line cord plug from the outlet.
 "Don't" sign.	

 Warning	
 Do not disassemble the unit. There is a high voltage present inside, possibly leading to an electric shock.	
 Do not modify the unit. Modifications may cause a fire and/or electric shock.	
 If any anomaly occurs, for example, heat or smoke is generated or an odor is emitted, unplug the unit immediately and contact your dealer for servicing. There is a danger that further use may cause a fire or electric shock.	
 Do not use any voltage of the power source other than designated. Do not share a single outlet with another plug. These may lead to fire or shock hazards.	
 Do not damage, break, or modify the power cord. Do not put a heavy object on, pull, or forcefully bend the cord, either. These may damage the cord, possibly resulting in a fire or electric shock.	

-  If foreign matter should get in the unit (including a piece of metal, water, or liquid), disconnect the plug from the outlet immediately and contact your dealer for servicing. There is a danger that further use may cause a fire or electric shock.
-  Do not plug or unplug the unit with a wet hand. You may get an electric shock.

 **Caution**

-  Do not place the unit on an uneven or tilted surface. This may result in injuries due to the unit dropping or falling off.
-  Do not put a water-filled container or a metal object on top of the unit. If water is spilled or the metallic object slips inside, a fire or shock hazard may occur.
-  Do not install the unit in a humid or dusty environment. It may cause a fire or electric shock.
-  Do not place the unit near kitchen counter or humidifier. Oil, smoke, or steam generating from them may cause fire or shock hazards.
-  Do not yank the power cord to disconnect from the outlet. Hold the plug with your hand to do so, or the cord may be damaged, possibly leading to a fire or electric shock.
-  Remove the line cord plug from the outlet before transferring the unit, or it may damage the cord, possibly leading to a fire or electric shock.
-  Be careful not to contact the print head, as you may get hurt or burned.
-  Make sure to insert the power plug as far as it will go. Improper insertion of the plug may develop fire or shock hazards.
-  Do not insert or drop any other time card than specified into the slot. Such misuse may cause a fire or electric shock.
-  If the unit should be dropped or the case be broken, unplug the unit and contact your dealer for servicing. Further use may lead to a fire or shock hazard.

Daily Care
For cleaning, turn the power off and wipe the case clean of dust and dirt with a dry cloth, etc.

2. FEATURES

For satisfying various customers' needs, the QR-395 offers a variety of print styles.

- Various card types are selectable.
 - VN card, S card, Weekly card, or Bi-Weekly card
- Calculates the elapsed time between IN/OUT punches and also prints a running total of accumulated time. (with a VN card)
 - A maximum of 100 cards can be automatically registered and used in a pay period.
- Simple operation for recording the time of IN/OUT punches.
 - Up to 4 columns per day or unlimited punches per day using a VN card is selectable.
- One line per day or unlimited lines per day is selectable.
- Monthly, weekly, or bi-weekly is selectable for pay period.
- For avoiding double punches in the same column.....
 - Automatic shifting print column is available with a VN card.
 - Weekly program can be set when you use a S card, a weekly card, or a bi-weekly card.
- You can program 2 types of schedules (when using the unit with calculation).
 - Common schedule/Extra schedule
- Selectable 6 print formats
 - Date + 24 hour, Day of the week + 24 hour, 24 hour in large font, AM/PM, Date + AM/PM, or Day of the week + AM/PM
- The unit resumes when the power returns after a power outage without any need for re-setting the date or time.
- You can set the automatic daylight saving time program.
- The languages English · Spanish · German · French · Italian · Portuguese can be selected to print the days of the week when applicable print format is selected.
- You can set the special mark printing that makes it possible to easily see an employee's late in or early out.
- The unit can be used on a table-top or mounted on a wall.

3. GETTING STARTED

Accessories

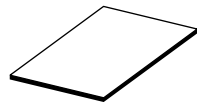

User's manual

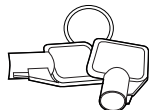

Keys

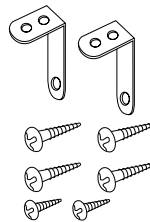

Wall mount hardware

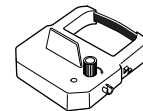

Ribbon cassette

Features

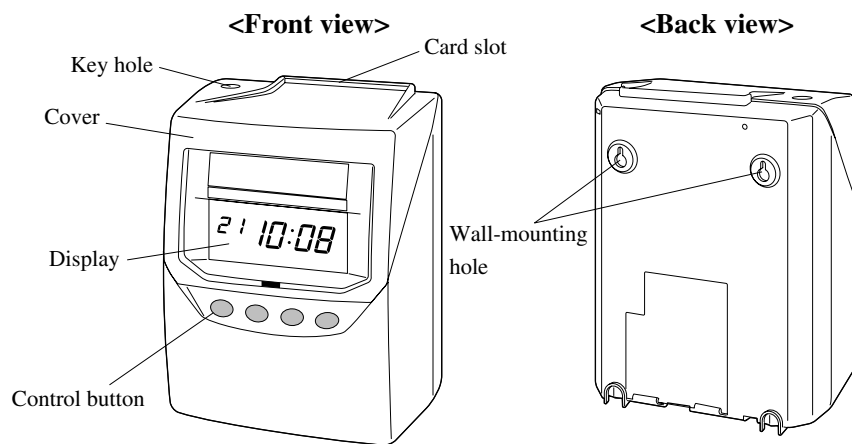

< Display >

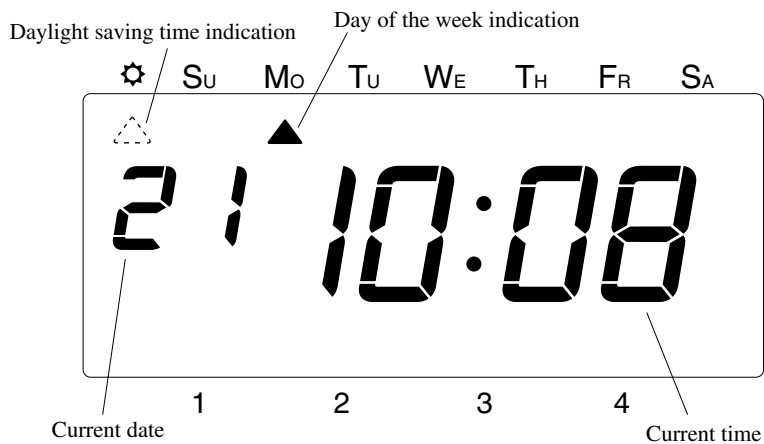

Installing the Ribbon Cassette

Make sure the power is on before installing.

- 1 Hold the left and right sides of the cover and lift up.

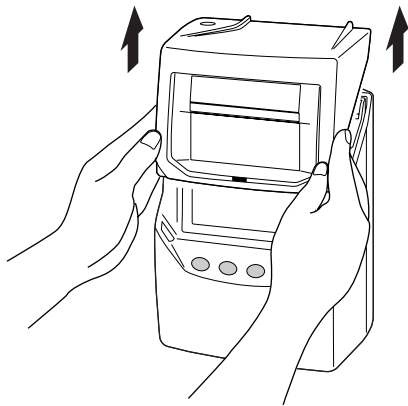

- 2 Turn the knob of the new ribbon cassette in the same direction as the arrow to tighten the ribbon.

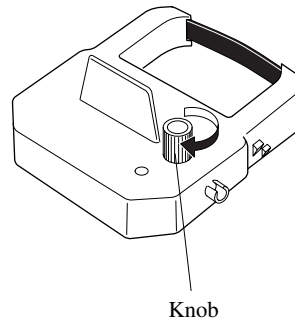

- 3 Place the ribbon cassette inside the time recorder as shown in the figure. Push the ribbon cassette until it snaps into the clasps on both sides. If it is difficult to insert the ribbon cassette, try it while turning the knob.

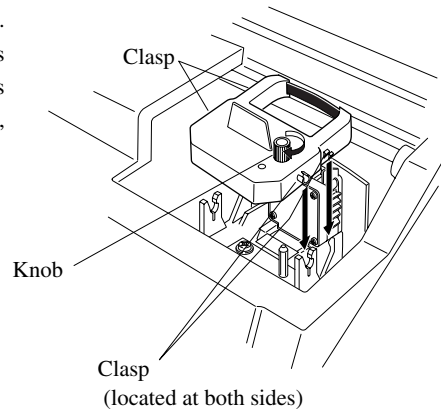

- 4** Install the ribbon cassette so that the ribbon is between the print head and the ribbon mask (see the figure on the left). Printing will not come out properly if the ribbon is placed behind the ribbon mask (see the figure on the right).

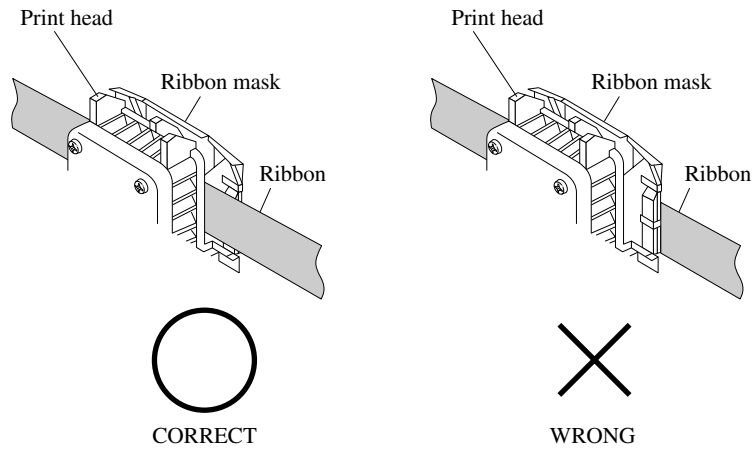

- 5** Turn the knob of the ribbon cassette in the direction of the arrow to tighten the ribbon.

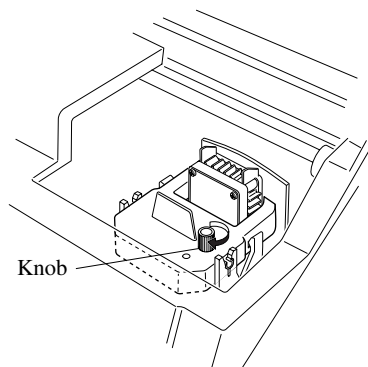

- 6** Leave the cover off while changing any settings in the next step. When the settings are complete, replace the cover.

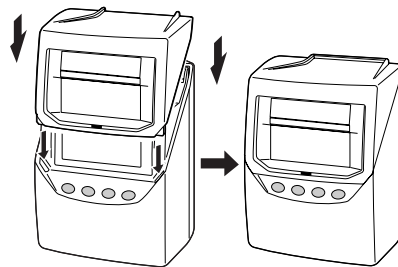

Installing the Unit

Note: The unit has an internal battery that will save the settings when unplugged.

The unit can be used on a table-top or mounted on a wall. When choosing a location, please note locations to avoid in "Environmental Conditions" at the bottom of the page. If you are using the unit as a table-top, find an appropriate place and skip to Step 3. If using as a wall-mount, take the following steps.

Mounting Unit on Wall

The unit can be mounted on a wall using the supplied mounting fittings.

- 1 Install wall mount screws (supplied) into a wall 10 cm (3 15/16") apart. Be sure to keep about 3 mm (1/8") of the screw head out of the wall. Use template on bottom of the next page if you prefer.



The supplied screws are intended for use on a thick wooden wall or wooden column. Do not use them on any other materials. There is a danger that the unit may come off if used on other materials.

- 2 Mount the wall mount fittings as shown on the right.
- 3 Plug the unit into power, and the unit is ready to use.

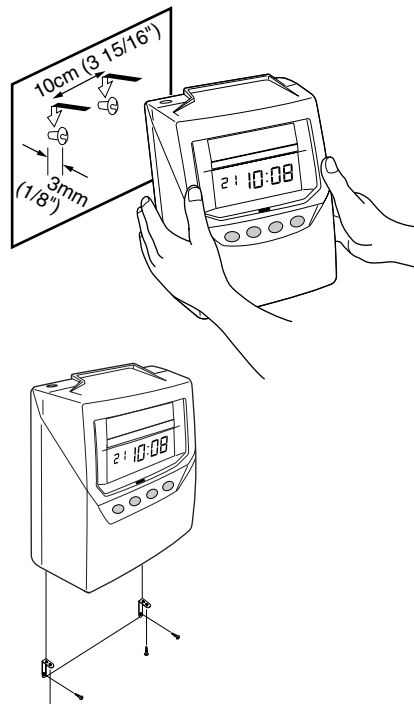

Environmental Conditions

Avoid placing the unit in environments that are:

- humid or dusty
- exposed to direct sunshine
- subject to frequent or continuous vibrations
- outside the temperature range between -5° and 45° C
- affected by chemicals or ozone

Template for wall mounting

Please copy and use this page when needed.

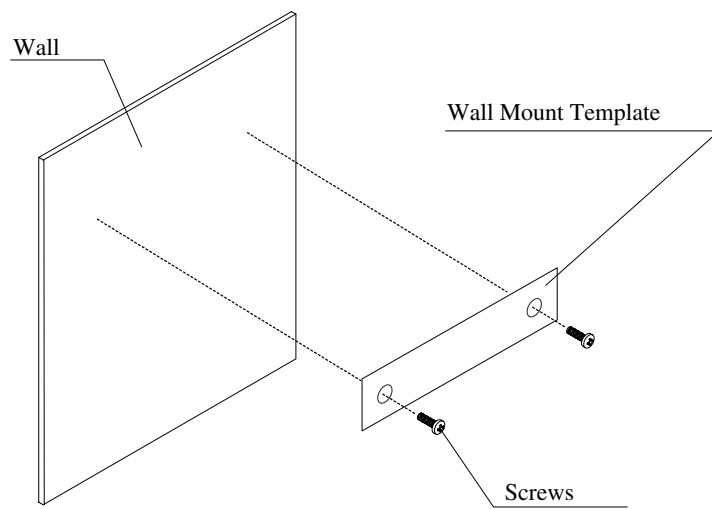

Leave about 3mm gap between wall and screw head.



8

4. DAILY OPERATIONS

Once the AC line cord is plugged into the outlet, the recorder can be used immediately. The time card is automatically pulled in, printed, and then ejected. Before you start using the unit, make sure to install a ribbon cassette in it.

See "3. GETTING STARTED".



Do not let any metallic object get into the slot, including paper clips. Do not forcefully push in a card, either. These may cause the unit to malfunction.

Basic settings are preset. When a new card is inserted, the first punch is printed in the first column on the time card. If you use the VN card, the recorder will remember the last imprint and automatically switch the "IN" and "OUT". If you use other time cards such as S cards, Weekly cards, or Bi-Weekly cards, printing column will not shift automatically unless weekly program is set. You may also manually switch the column position of the imprint by pushing the button.

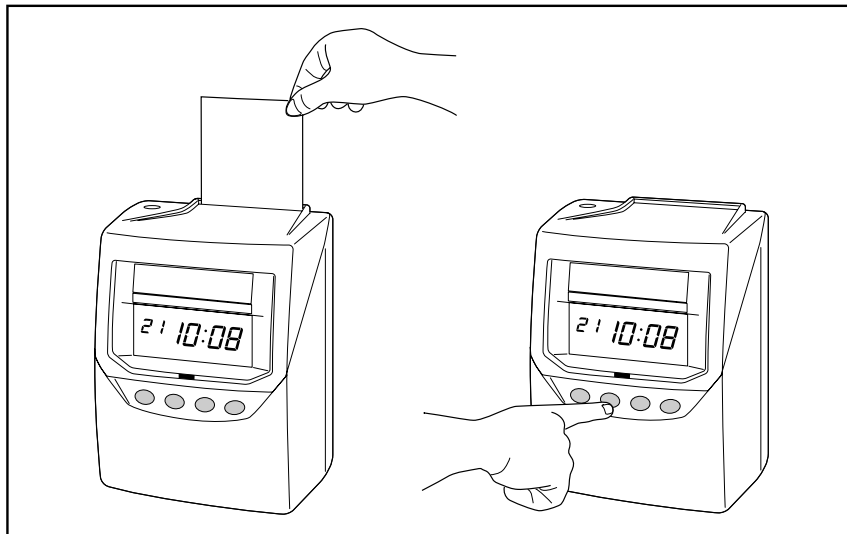

Refer to the next page for default setting in the clock. If any setting needs to be changed, refer to "5. BASIC SETTINGS" and "6. ADVANCED SETTINGS" in the following pages.

As you can see in the list, preset card type is VN card with calculation.



If you don't need calculation, you must change the "Card Type" before using the unit.

Default Setting

Setting	Default Setting	Note
Display Hours	24hour	
Time	00:00	*1
Date	1st Jan. 2000	*1
Day Advance Time	5:00	
Card Type and Pay Period	VN card with calculation, Monthly, 31	VN card is a time card with barcode.
Daylight Saving Time	No setting	
Print Format	Print format: Date, 24hour Minute Type: Regular Minute (1/60) Print Language: English	
Schedule	No setting	*2
Rounding	1 min., prints totals calculated to exact minute	*2
Weekly Program	No setting	*3
Password	No setting	

*1: Date and time are set at the same day of shipment by factory default setting.

*2: These settings are available only when you use the clock with calculation.

*3: This setting is available only when you use the clock without calculation.

For detailed explanation of each setting, refer to "5. BASIC SETTINGS" and "6. ADVANCED SETTINGS" in the following pages.

5. BASIC SETTINGS

Preparation for setting

To prepare for setting:

! Make sure the power is on before making setting.

1 Unlock the cover.

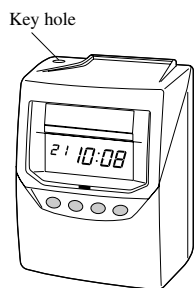

2 Hold the sides of the cover with both hands, and lift it.

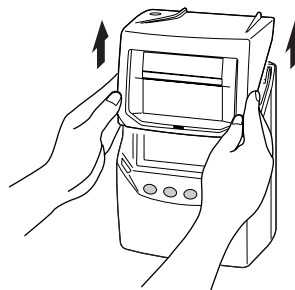

3 Make settings using the control button while watching the display. Please refer to the following pages for the details of each setting.

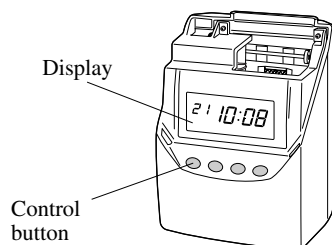

4 After the setting has been completed, fit the plugs at the lower sides of the cover into the holes of the unit. Replace the cover.

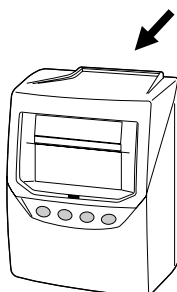
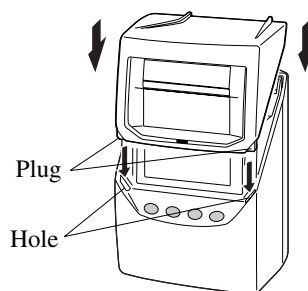

Selecting the Display Hours

"Display hours" is the format that the hours appear on the clock face. The default is "24 hour".

Type of hour	Example
1. AM/PM	PM 3:30
2. 24 hour	15:30

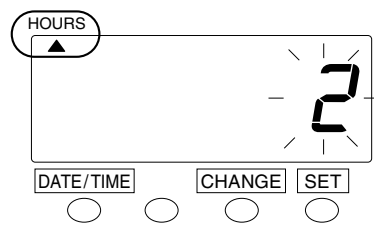

1 Push the **DATE/TIME** button for 3 seconds and position the "▲" under the "HOURS" mark.

2 Once a number on the display starts flashing, push the **CHANGE** button to select either "AM/PM" or "24 hour". For example, set 2 if "24 hour" is desired.

3 Push the **SET** button to finish the setting. At that moment, the display will change from flashing to steady, and the setting is now completed.

4 Push the **SET** button once again.

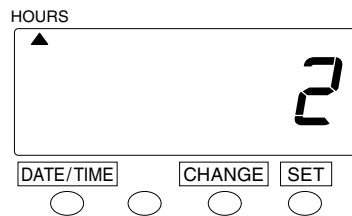

Setting the Time

Example: To change the time from 10:08 to 10:09

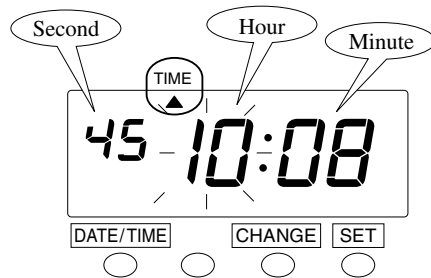

1 Push the **DATE/TIME** button for 3 seconds.

2 Push the **DATE/TIME** button and position the "▲" under the "TIME" mark.

The flashing number can be changed.

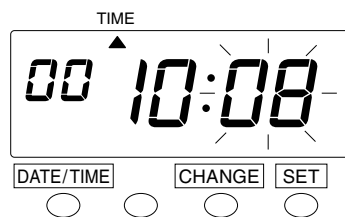

3 Press the **CHANGE** button to change the hour. In the example, the hour is not to be changed. Push the **SET** button to accept, and the flashing of the display changes from "Hour" to "Minute".

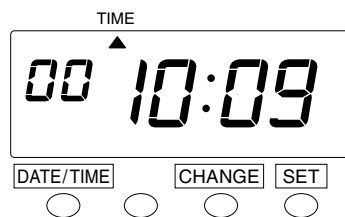

4 Change the "Minute" (for example, from 8 minutes to 9 minutes). Push the **CHANGE** button to set "Minute" at "09" and then push the **SET** button. Now the minutes of 9 have been set.

5 Push the **SET** button once again.

Setting the Date

Example: Change the date from October 20, 2012 to October 21, 2012.

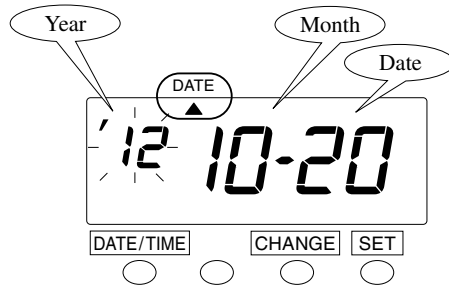

1 Push the **DATE/TIME** button for 3 seconds.

2 Push the **DATE/TIME** button and position the "▲" under the "DATE" mark.

The flashing number can be changed.

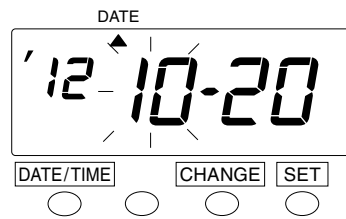

3 In the example, push the **SET** button because the year 2012 is not to be changed. Now the year of 2012 has been set.

At that moment, the flashing of the display will change from "Year" to "Month".

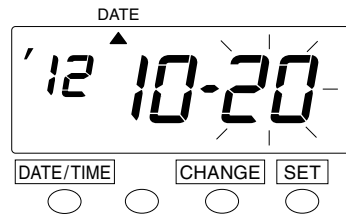

4 In the example, the month is not to be changed. Push the **SET** button to accept, and the flashing of the display changes from "Month" to "Date".

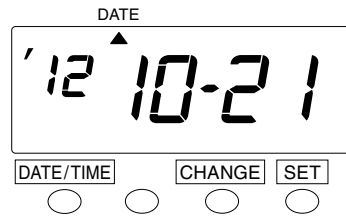

5 Change the "Date" (for example, from 20 to 21).

Push the **CHANGE** button to set "Date" at "21" and then push the **SET** button, and now the date of 21 has been set.

At that moment, "Date" on the display will change from flashing to steady, and the date change setting is now completed.

6 Push the **SET** button once again.

Setting the Day Advance Time

The day advance time refers to the time when printing shifts to the next line on a time card for the next day. This function enables the punch out time record to print on the same line of the previous working day even if leaving time is after midnight.

The clock default is 5:00.

If error "E-49" appears when you try to change settings, then you must reset all cards before proceeding. (See "All Cards Reset".)

Example: Change the line shift time from 5:00 a.m. to 7:00 a.m.

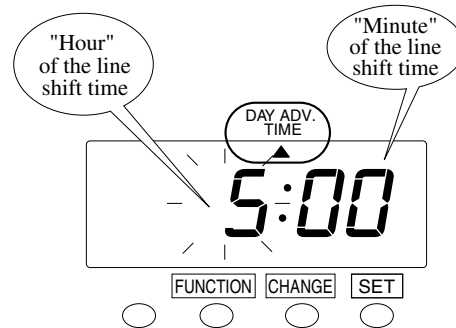

1 Push the **FUNCTION** button for 3 seconds.

2 Push the **FUNCTION** button and position the "▲" under the "DAY ADV. TIME" mark.

The flashing number can be changed.

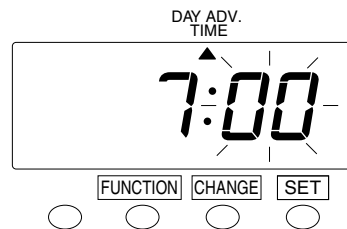

3 Change "Hour" of the line shift time (for example, from 5:00 to 7:00). Push the **CHANGE** button to set "Hour" at "7", and then push the **SET** button.

At that moment, the flashing of the display will change from "Hour" to "Minute".

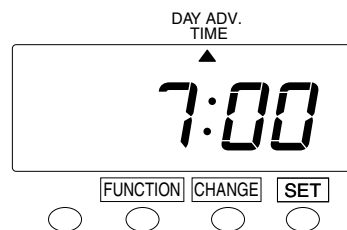

4 In the example, the "Minute" is not to be changed. Push the **SET** button again to accept, and the display changes flashing to steady.

5 Push the **SET** button once again.

Selecting the Card Type and Pay Period

To satisfy various users' demands, the QR-395 offers the following options.

You can select either one based on your needs.

Clock default is "C1" with monthly pay period (pay period ending date: 31).

Order Options	Card Type	Calculation	Printing Line	Pay Period *1		
C1	VN card (with barcode)	Yes	Free (as many lines	M	W	BW
C2		No	as you like)	✓	✓	✓
C3		Yes	One line per day	✓	✓	✓
C4	No	✓		✓	✓	
C5		S card		✓		
C6		Weekly Card			✓	
C7		Bi-Weekly			✓	

*1: M = Monthly, W = Weekly, BW = Bi-Weekly

Print example of a time Card

Option: C1

VN cards (= barcoded time cards) with calculation

Printing line per day: Not fixed (as many punches as you like per day)

		Total	
IN	OUT	Daily	Accumulation
☐ 9:00	☐ 17:00	8:00	8:00
☒ 9:00	☒ 12:00	3:00	11:00
☓ 13:00	☓ 17:00	4:00	15:00
☔ 17:30	☔ 18:30	1:00	16:00
☕ 9:00	☕ 17:00	8:00	24:30
☖ 9:00	☖ 17:00	8:00	32:30
☗ 9:00	☗ 17:00	0:00	40:00

} Several punches
on the same day

Option: C2

VN cards (= barcoded time cards) without calculation,

Printing line per day: Not fixed (as many punches as you like per day)

IN	OUT	IN	OUT
☐ 9:00	☐ 10:00	☐ 10:15	☐ 12:00
☒ 12:45	☒ 15:00	☒ 15:30	☒ 17:00
☓ 9:00	☓ 12:00	☓ 13:00	☓ 18:00
☔ 9:00	☔ 10:00	☔ 10:15	☔ 12:30
☕ 12:45	☕ 17:00		
☖ 9:00	☖ 12:00		
☗ 9:00	☗ 18:00		

} You can punch more than 4
times per day.
(Up to 4 punches per line)

Option: C3

VN cards (= barcoded time cards) with calculation

Printing line per day: Fixed, up to 2 punches (= 1 set of IN/OUT punches) per day

		Total	
IN	OUT	Daily	Accumulation
☐ 9:00	☐ 17:00	8:00	8:00
☒ 9:00	☒ 17:00	8:00	16:00
☓ 9:00	☓ 17:00	8:00	24:00
☔ 9:00	☔ 17:00	8:00	32:00
☕ 9:00	☕ 17:00	8:00	40:00

← Line is skipped on a day off.

Option: C4

VN cards (= barcoded time cards) without calculation

Printing line per day: Fixed, up to 4 punches (= 2 sets of IN/OUT punches) per day

IN	OUT	IN	OUT
1 9:00	1 12:00	1 13:00	1 17:00
2 9:00	2 12:30	2 13:30	2 17:30
3 9:00	3 12:00	3 13:00	3 18:00
4 9:00	4 12:00		
5 9:00	5 18:00		

← Line is skipped on a day off.

Option: C5, C6, and C7

Time cards without calculation

Printing line per day: Fixed, up to 4 punches (= 2 sets of IN/OUT punches) per day

IN	OUT	IN	OUT
1 9:00	1 12:00	1 13:00	1 17:00
2 9:00	2 12:30	2 13:30	2 17:30
3 9:00	3 12:00	3 13:00	3 18:00
4 9:00	4 12:00		
5 9:00	5 18:00		

← Line is skipped on a day off.

Please go to the next page for setting.

Only for VN Card Users

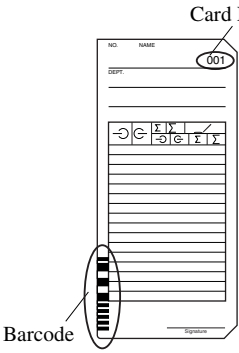

Card Number

When you select "VN Card", the clock will remember the last imprint and automatically switch the "IN" and "OUT" columns by distinguishing each card with barcode. (Up to 100 cards can be used for one period.)

Barcode

Setting the Card Type and the Pay Period

If error "E-49" appears when you try to change settings, then you must reset all cards before proceeding. (See "All Cards Reset" on page 49.)

Example: Change "C1" with weekly period to "C4" with monthly period (pay period ending date: 31).

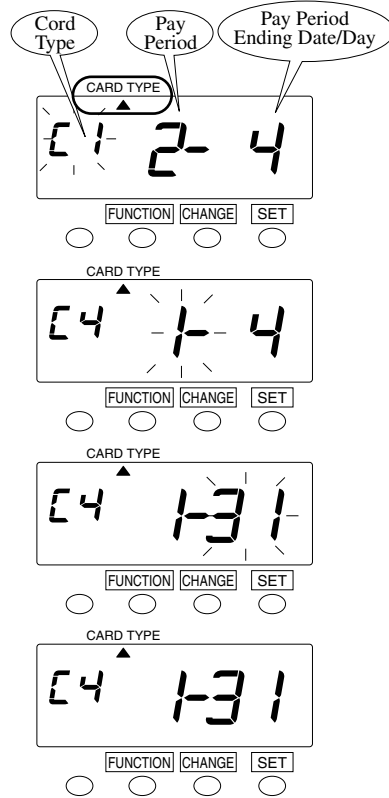

- 1 Push the **FUNCTION** button for 3 seconds and position the "▲" under the "CARD TYPE" mark.

The flashing number can be changed.

- 2 Push the **CHANGE** button to set the left-side number at "C4" and then push the **SET** button. At that moment, the flashing changes to "Pay Period".

- 3 Push the **CHANGE** button to set the middle number at "1" for "Monthly Period" and then push the **SET** button. At that moment, the flashing changes to "Pay Period Ending Date".

- 4 Push the **CHANGE** button to set the right-side number at "31" and then push the **SET** button. At that moment, the display will change from flashing to steady and the setting is now completed.

For setting the Pay Period Ending Date/Day, see "How to set the Pay Period Ending Date/Day" on the next page.

- 5 Push the **SET** button once again.

When you select "C5", "C6", or "C7"

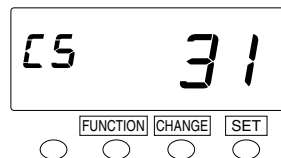

Pay period is fixed when you select "Card Type". After the Step 2, the display will be as shown in the left figure and the Step 3 is skipped. You only have to do is set the pay period sending date/day in the Step 4.

How to Set the Pay Period Ending Date/Day

Monthly Period

- 1 Push the **CHANGE** button to set the desired date. For example, if the pay ending date is the 20th, set the pay ending date at 20.

Note: If the pay ending date is the end of the month, make sure to set at "31".

- 2 Push the **SET** button to finish the setting. At that moment, the display will change from flashing to steady, and the setting is now completed.

Weekly Period

Set the desired pay period ending day, which comes within a week from today.

Example

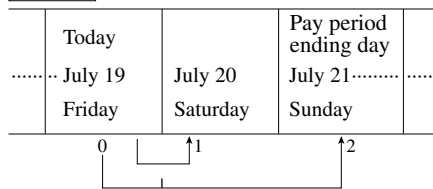

Assume that today is Friday, July 19, 2013 and the pay period ending day is Sunday. As illustrated in the left figure, the ending day (Sunday) is two days after.

- 1 Push the **CHANGE** button to set the right-side number of the display at "2".
- 2 Push the **SET** button to finish the setting. At that moment, the display will change from flashing to steady, and the setting is now completed.

Bi-Weekly Period

Set the desired pay period ending day, which comes within two weeks from today.

Example

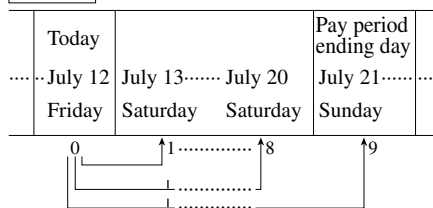

Assume that today is Friday, July 12, 2013 and the pay period ending day is Sunday the week after next. As illustrated in the left figure, the ending day (Sunday) is nine days after.

- 1 Push the **CHANGE** button to set the right-side number of the display at "9".
- 2 Push the **SET** button to finish the setting. At that moment, the display will change from flashing to steady, and the setting is now completed.

Setting the Daylight Saving Time

Daylight saving time function

❶ D.S.T. execution time

At 2:00 a.m. on the first day of summer time, the clock automatically gains one hour to show 3:00 a.m. When 3:00 a.m. comes on the last day of the summer time period, it loses one hour and returns to 2:00 a.m.

❷ Setting D.S.T.

Example:

Start date Sunday, March 31, 2013

End date Sunday, October 27, 2013

If set as the above, the unit remembers the start date as the last Sunday of March and the end date as the last Sunday of October. Once set, the unit automatically updates the settings every year thereafter. No further manual setting is necessary.

When there is a time change between the "IN" and "OUT" because of the "Daylight Savings" settings, an "S" will appear on the calculated result as a record mark.

In order to prevent miscalculations on the day you adjust the "Daylight Savings" time, punching "OUT" the next day is not desirable.

The "S" mark may not be printed properly when "Daylight Savings" turned on because of other changes in settings.

The setting for daylight saving time will be described using the following example.

Example

Today (present day)	Wednesday, November 21, 2012	
Starting date of daylight saving time	Sunday, March 31, 2013	The last Sunday of March
Ending date of daylight saving time	Sunday, October 27, 2013	The last Sunday of October

1 Push the **FUNCTION** button for 3 seconds.

2 Push the **FUNCTION** button and position the "▲" next to the "DAYLIGHT SAVING" mark.

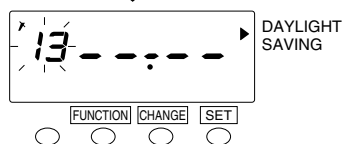
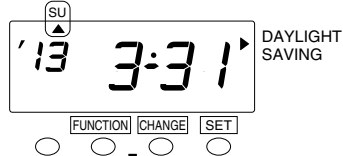
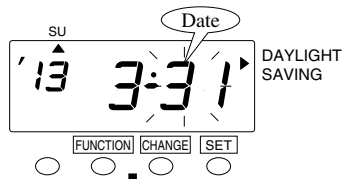
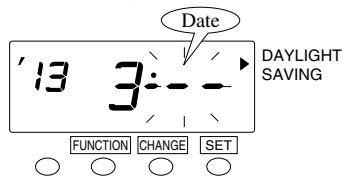
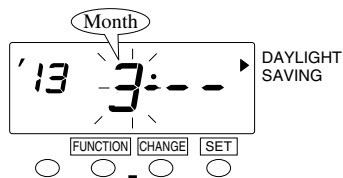
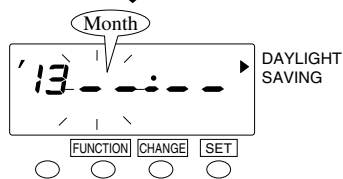
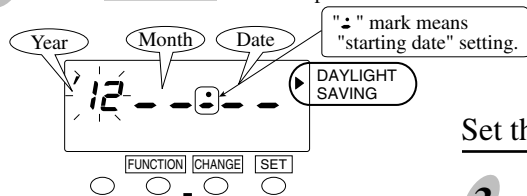

Set the "starting date".

3 In the case of the example, push the **CHANGE** button to set at "13" and push the **SET** button.

At that moment, the flashing changes from "Year" to "Month".

4 Push the **CHANGE** button to set at "3" and push the **SET** button.

At that moment, the flashing changes from "Month" to "Date".

5 Push the **CHANGE** button to set at "31" and push the **SET** button.

At that moment, "starting date" of the display changes from flashing to steady and the "▲" mark is displayed under "SU". Wait a few seconds, then start on Step 6.

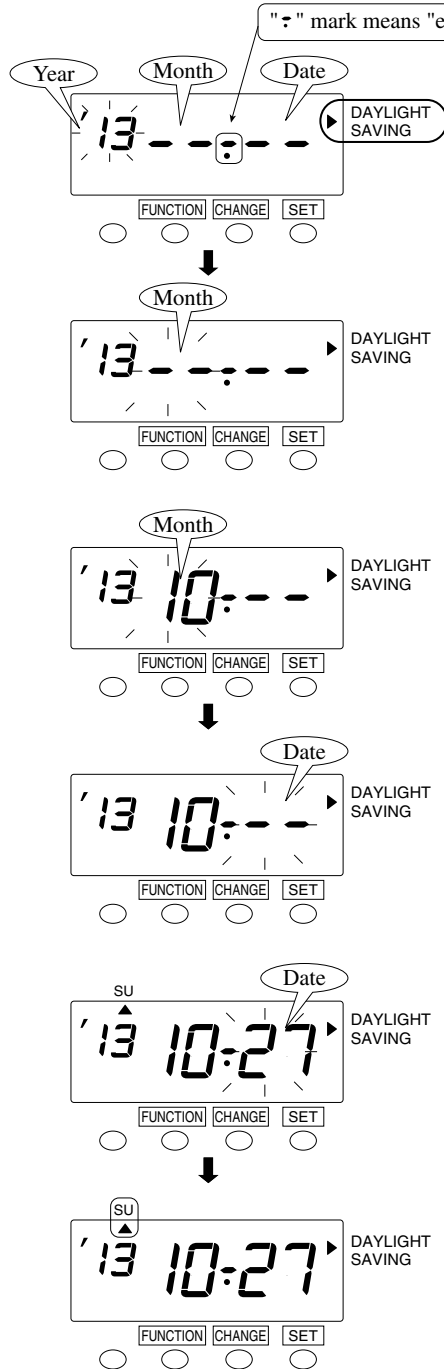

Set the "ending date".

6 Next, push the **SET** button. At that moment, the flashing changes "Year" to "Month".

7 Push the **CHANGE** button to set at "10" and push the **SET** button. At that moment, the flashing changes from "Month" to "Date".

8 Push the **CHANGE** button to set at "27" and push the **SET** button. At that moment, "ending date" of the display changes from flashing to steady and the " \blacktriangle " mark is displayed under "SU".

9 Push the **SET** button once again.

Deleting the Daylight Saving Time Settings

For cancelling the daylight saving time setting, change the "Month" of the starting date to two dashes, or "--".

- 1 Push the **FUNCTION** button for 3 seconds.
- 2 Push the **FUNCTION** button and position the "▲" next to the "DAYLIGHT SAVING" mark.

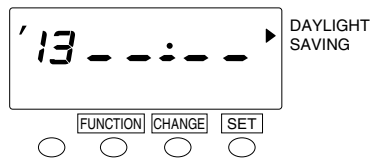
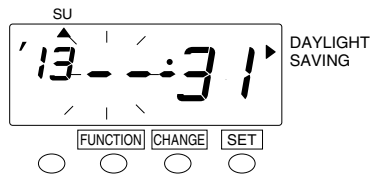
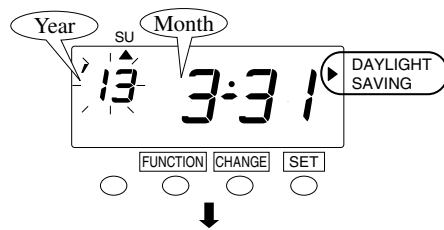

- 3 Push the **SET** button and the flashing changes from "Year" to "Month".
Next, push the **CHANGE** button until the "Month" changes to two dashes, or "--". The two dashes are the next setting after '12'.

- 4 Push the **SET** button twice. This cancels the daylight saving time settings.

- 5 Push the **SET** button once again.

Selecting the Print Format

You can select desired print format from the following options.

If error "E-49" appears when you try to change settings, then you must reset all cards before proceeding. (See "All Cards Reset".)

Print Format

The clock default is "1. Date, 24HR".

Order Options	Line Format	Print Example: Monday, 21, 15:30
1. Date, 24HR	date, 24hour, minute	21 15 : 30
2. D.O.W. 24HR	day of the week, 24hour, minute	Mo 15 : 30
3. 24HR Large Font *1	24hour, minute	15 : 30
4. AM/PM *1	12hour, minute	PM 3 : 30
5. Date, AM/PM	date, 12hour, minute	21 3 : 30 P
6. D.O.W AM/PM	day of the week, 12hour, minute	Mo 3 : 30 P

*1: When you use the clock with calculation (= select "C1" or "C3" in "Card Type" setting, these 2 options can not be selectable.

Minute Type

The clock default is "1. Regular minutes (1/60)."

Order options	Print Example: 8:34
1. Regular Minutes (1/60)	8: 34
2. Hundredths (1/100) *2 *3	8. 57

*2: Once you select "Hundredths (1/100)", rounding setting will return to the clock default.

If necessary, see the "Setting Rounding" section in this manual.

*3: When you use the clock with calculation (= select "C1" or "C3" in "Card Type" setting, only calculation result is printed in "Hundredths (1/100)". IN and OUT punches are always printed in "Regular Minutes (1/60)".

Language

You can select desired language from the following 6 options for day of the week indication.

This setting is available only when you select a print format which includes day of the week.

(Option 2 or 6 in the above "Print Format".)

The clock default is "1. English".

Order options	Print example: Thursday 15:30
1. English	TH 15 : 30
2. Spanish	JU 15 : 30
3. German	DO 15 : 30
4. French	JE 15 : 30
5. Italian	GI 15 : 30
6. Portuguese	QI 15 : 30

Example: Change the Print Format to "Day of the week + 24 hour" in French and the Minute Type to "Hundredths (1/100)".

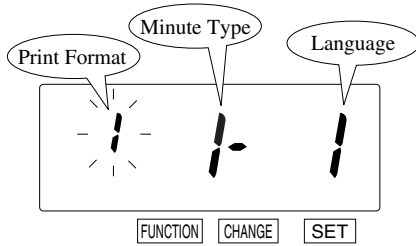

1 Push the **FUNCTION** button for 3 seconds.

2 Push the **FUNCTION** button and position "▲" next to the "PRINT FORMAT" mark.

The flashing number can be changed.

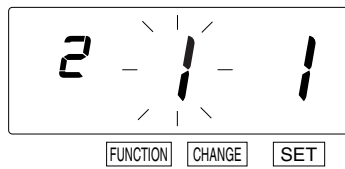

3 Select the "Print Format".

Push the **CHANGE** button to set the left-side number at "2" for "D.O.W., 24HR" and then push the **SET** button. At that moment, the flashing changes to "Minute Type".

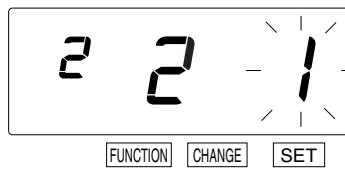

4 Select the "Minute Type".

Push the **CHANGE** button to set the middle number at "2" for "Hundredths (1/100)" and then push the **SET** button. At that moment, the flashing changes to "Language".

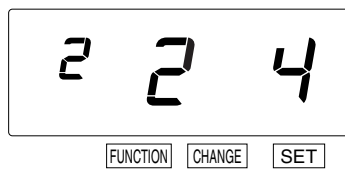

5 Select the "Language".

Push the **CHANGE** button to set the right-side number at "4" for "French" and then push the **SET** button. At that moment, the display will change from flashing to steady and the setting is now completed.

6 Push the **SET** button once again.

6. ADVANCED SETTINGS

Schedule

This setting is available only when you use the VN cards WITH calculation.
(Only when you've selected "C1" or "C3" in the "Card Type" setting.)

You can select one of two types of schedules. You have the choice from a "Common schedule", which literally will be common with all days of the week, and from an "Extra schedule" that prioritizes the special 2 days of the week.

Each schedule is made from an "Calculation effective time zone" and maximum settings of 4 "Break times", and you can regulate the day's working rules. The day's partition that is the schedule's standard is the "Day advance time", and this time is optional.

Example:

Common schedule

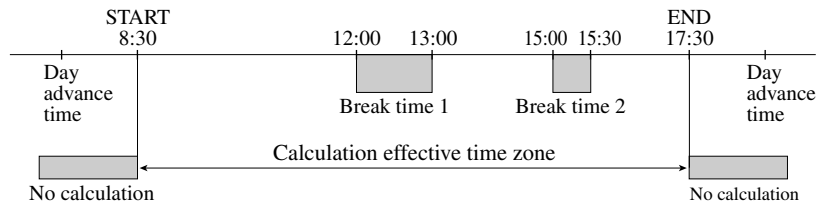

Extra schedule

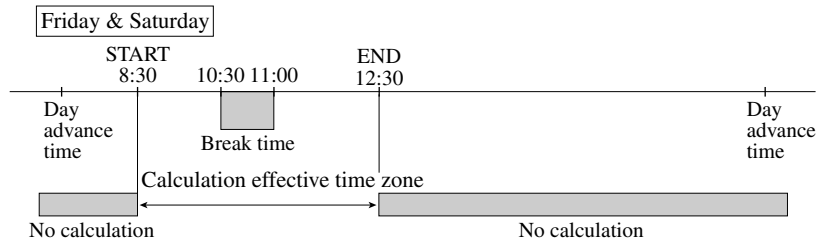

If you don't set the "Calculation effective time zone", you can regulate worked hours of the day by setting the "Max in value". This is the maximum hours from IN punch, which limit the time to accept the following punch as OUT punch. This rule permits employees to punch IN and OUT without being assigned to a fixed schedule. (When the "Max in value" is set, you can exceed the "Day advance time".) Employee's times are calculated using elapsed time or punched IN time subtracted from punched OUT time. In case you select "C3" in the "Card Type" setting and exceed the "Max in value" within the same day, no more punch is accepted on the rest of the day until the next "Day advance time" comes. Then, the next punch is regarded as the 1st IN punch on the next day when you exceed the "Day advance time".

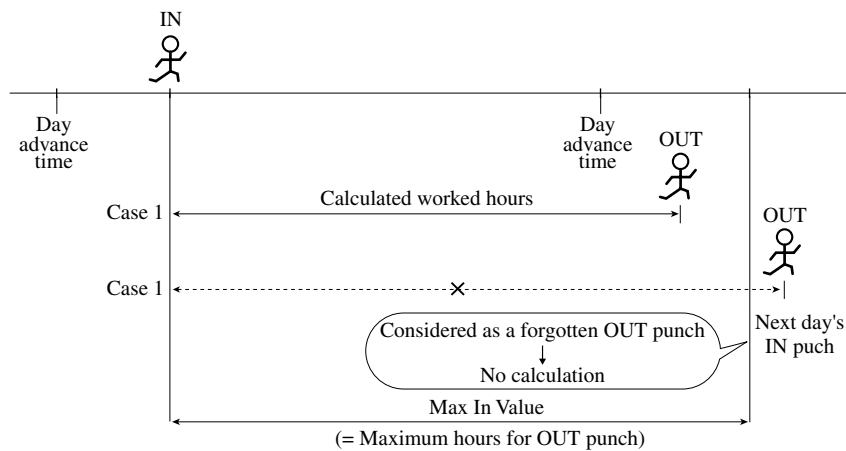

When you reach the "Max in value" within the same day.....
(In case the option "C3" is selected in the "Card Type" setting)

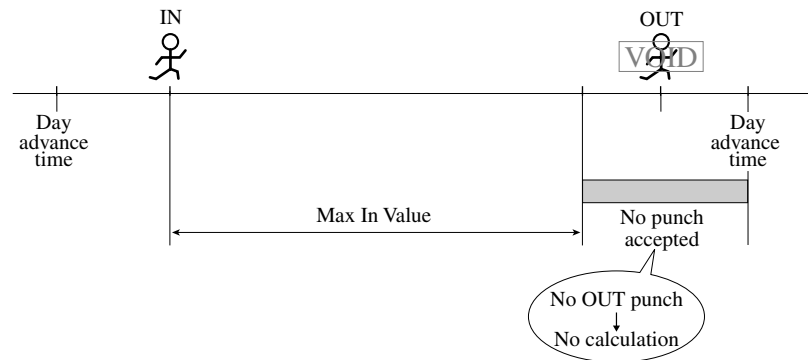

Setting the Schedule

Common Schedule

Example 1

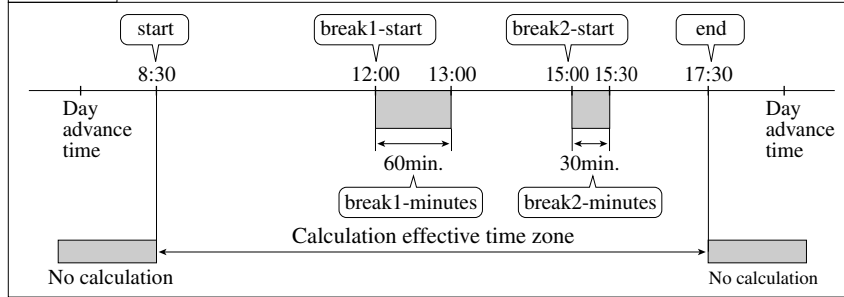

- 1 Push the **FUNCTION** button for 3 seconds.
- 2 Push the **FUNCTION** button and position the "▲" under the "COMMON SCHEDULE" mark.

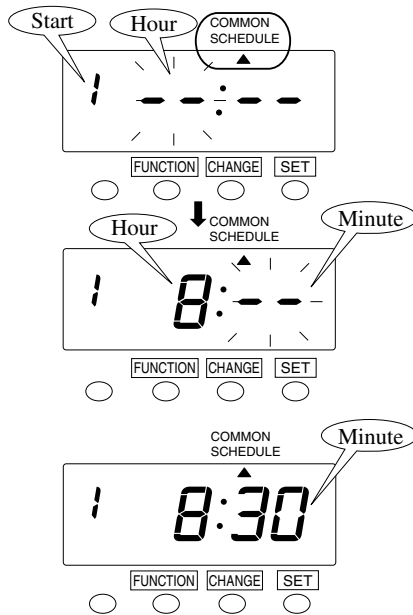

Set the "start" time.

- 3 Push the **SET** button. At that moment, the flashing changes to "Hour". In the case of the example, push the **CHANGE** button to set at "8" and push the **SET** button. At that moment, the flashing changes from "Hour" to "Minute".
- 4 In this case, push the **CHANGE** button to set at "30". And then push the **SET** button.

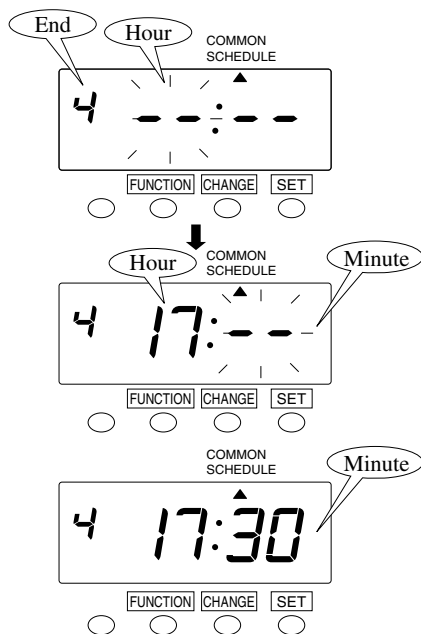

Set the "end" time.

- Next, push the **CHANGE** button 4 times to set the left-side number at "4" and then push the **SET** button. At that moment, the flashing changes to "Hour". In the case of the example, push the **CHANGE** button to set at "17" and then push the **SET** button. At that moment, the flashing changes from "Hour" to "Minute".

- In this case, push the **CHANGE** button to set at "30" and then push the **SET** button.

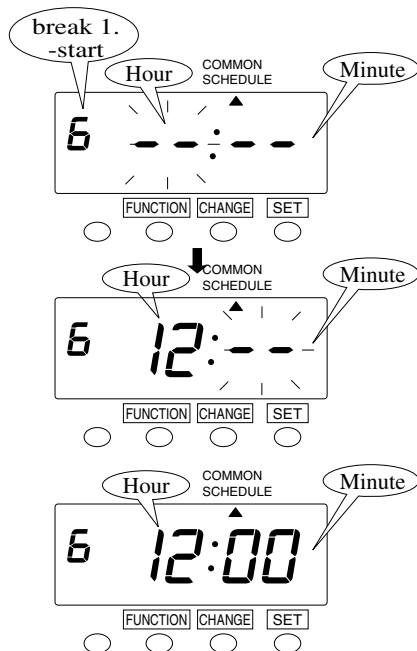

Set the "break 1-start" time.

- Push the **CHANGE** button 3 times to set the left-side number at "6" and push the **SET** button. At that moment, the flashing changes to "Hour". In the case of the example, push the **CHANGE** button to set at "12" and then push the **SET** button. At that moment, the flashing changes from "Hour" to "Minute".

- In this case, push the **CHANGE** button to set at "00" and then push the **SET** button.

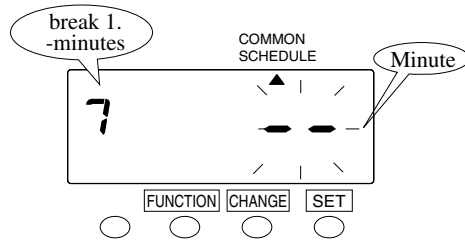

Set the "break 1-minutes".

9 Next, push the **CHANGE** button twice to set the left-side number at "7" and then push the **SET** button. At that moment, the flashing changes to "Minute".

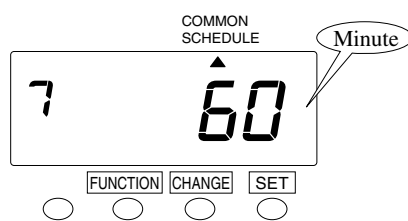

10 In this case, push the **CHANGE** button to set at "60" and then push the **SET** button.

Range of values: 1-90 min.

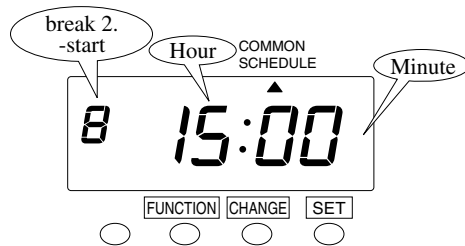

Set the "break 2-start" time.

11 Make setting for the "break 2-start" time in the same manner as for the "break 1-start" time, as illustrated in the figure on the left.

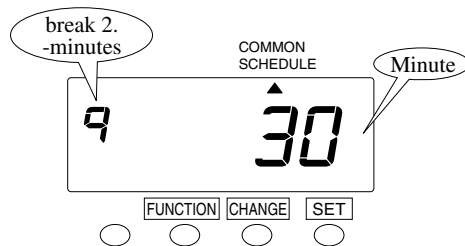

Set the "break 2-minutes".

12 Make setting for the "break 2-minutes" in the same manner as for the "break 1-minutes", as illustrated in the figure on the left.

13 Push the **SET** button once again.

Extra Schedule

Priority is given to "Extra schedule" over "Common schedule".

Example 3

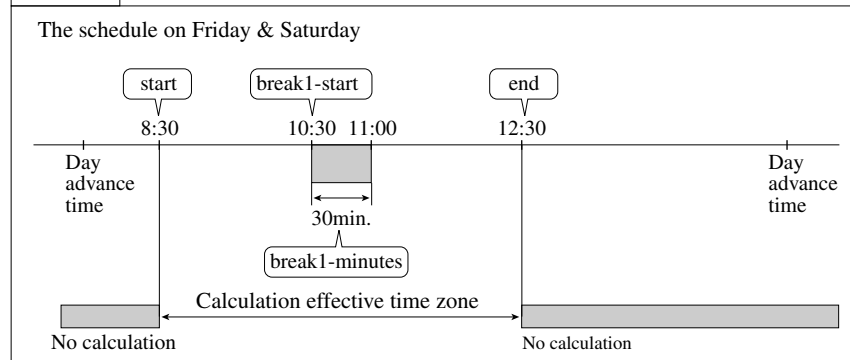

- 1 Push the **FUNCTION** button for 3 seconds.
- 2 Push the **FUNCTION** button and position the "▲" under the "EXTRA SCHEDULE" mark.

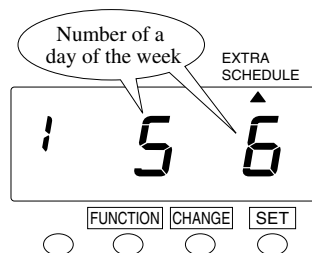
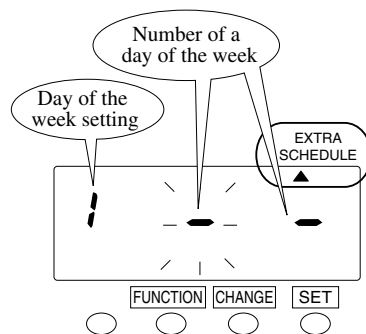

Set the "day of the week".

1	Monday	5	Friday
2	Tuesday	6	Saturday
3	Wednesday	7	Sunday
4	Thursday		

- 3 Push the **SET** button. At that moment, the flashing changes to "Number of a day of the week".
- 4 In this case, push the **CHANGE** button to set at "5" and then push the **SET** button.
- 5 Next, push the **CHANGE** button to set at "6" and then push the **SET** button.

When the extra schedule is applied to only one day in the week, leave the right digit "-".

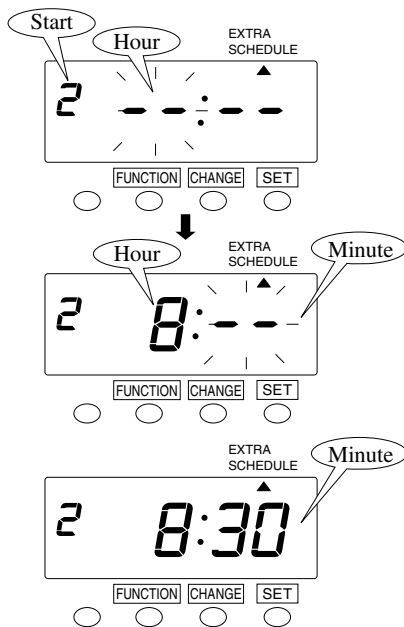

Set the "start" time.

- 6 Push the **CHANGE** button twice to set the left-side number at "2" and then push the **SET** button. At that moment, the flashing changes to "Hour". In the case of the example, push the **CHANGE** button to set at "8" and then push the **SET** button. At that moment, the flashing changes from "Hour" to "Minute".

- 7 In this case, push the **CHANGE** button to set at "30" and then push the **SET** button.

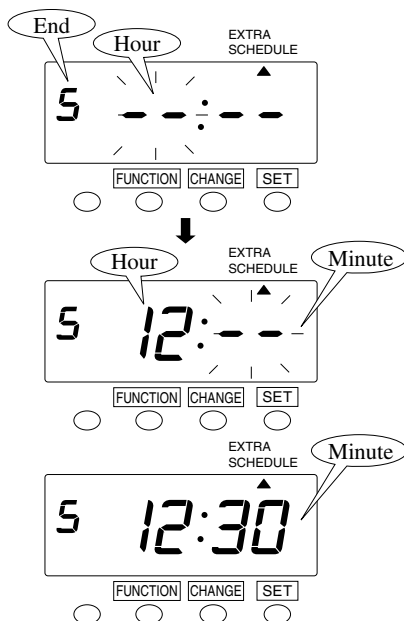

Set the "end" time.

- 8 Next, push the **CHANGE** button 4 times to set the left-side number at "5" and then push the **SET** button. At that moment, the flashing changes to "Hour". In the case of the example, push the **CHANGE** button to set at "12" and then push the **SET** button. At that moment, the flashing changes from "Hour" to "Minute".

- 9 In this case, push the **CHANGE** button to set at "30" and then push the **SET** button.

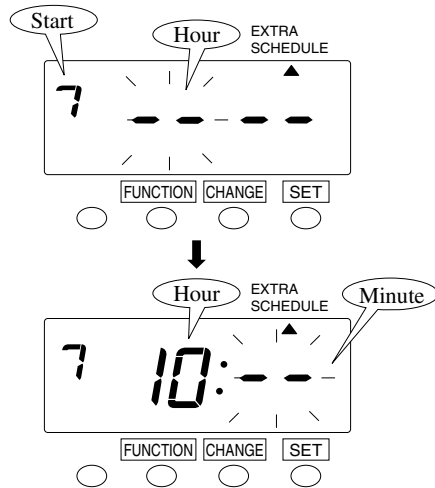

Set the "break 1-start" time.

10 Push the **CHANGE** button 3 times to set the left-side number at "7" and push the **SET** button.

At that moment, the flashing changes to "Hour".

In the case of the example, push the **CHANGE** button to set at "10" and then push the **SET** button.

At that moment, the flashing changes from "Hour" to "Minute".

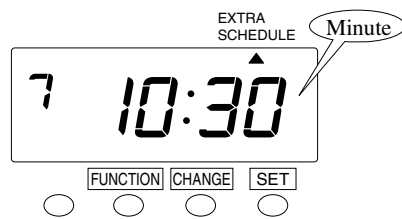

11 In this case, push the **CHANGE** button to set at "30" and then push the **SET** button.

Set the "break 1-minutes".

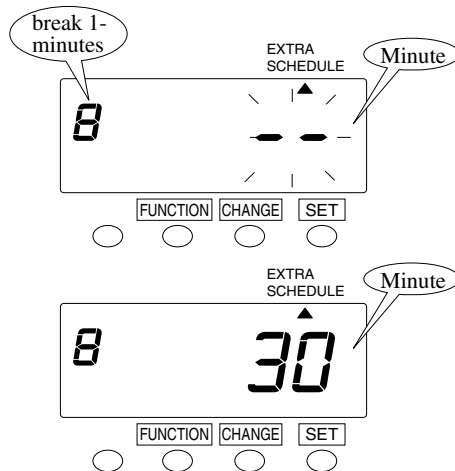

12 Next, push the **CHANGE** button twice to set the left-side number at "8" and then push the **SET** button.

At that moment, the flashing changes to "minute".

13 In this case, push the **CHANGE** button to set at "30" and then push the **SET** button.

Range of values: 1-90 min.

14 Push the **SET** button once again.

Max In Value

If the "Calculation effective time zone" is not set, you can regulate the worked hours of the day by setting the "Max In Value".

Example 2

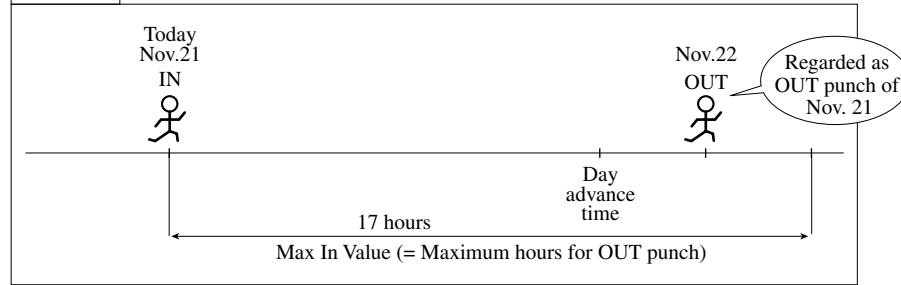

- 1 Push the **FUNCTION** button for 3 seconds.
- 2 Push the **FUNCTION** button and position the "▲" under the "COMMON SCHEDULE" mark.

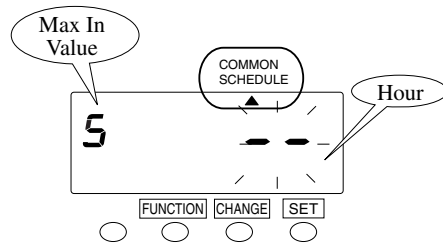

- 3 Push the **CHANGE** button 5 times to set the left-side number at "5" and then push the **SET** button. (In case of "EXTRA", set at "6".) At that moment, the flashing changes to "Hour".

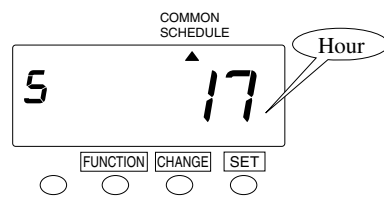

- 4 In this case, push the **CHANGE** button to set at "17" and then push the **SET** button.

Range of values: 1-24 hr.

- 5 Push the **SET** button once again.

Special Mark Printing

You can set the special mark printing "!" which means the punch between "Core start time" and "Core end time" except "Break time".

Special mark printing makes it possible to easily see an employee's late in or early out.

Example

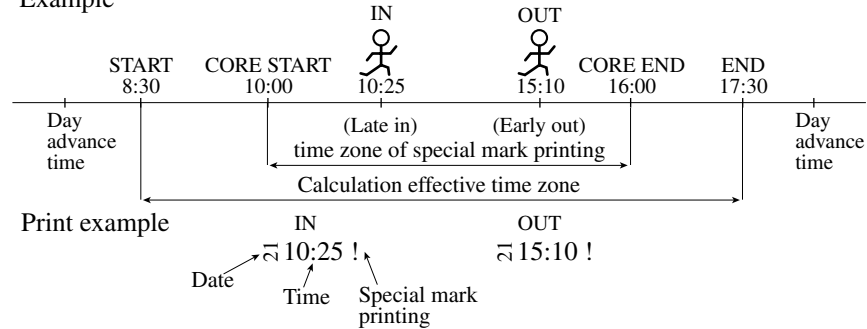

Setting the Special Mark Printing

Example: Core time starts at 10:00 and ends at 16:00 for special mark printing.

- 1 Push the **FUNCTION** button for 3 seconds.
- 2 Push the **FUNCTION** button and position the "▲" under the "COMMON SCHEDULE" or "EXTRA SCHEDULE" mark.

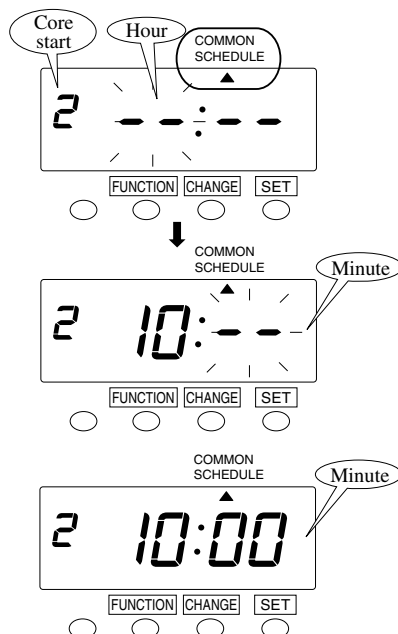

Set the "core start" time.

- 3 Push the **CHANGE** button to set the left-side number at "2" and then push the **SET** button. (In case of "EXTRA", set at "3".)
At that moment, the flashing changes to "Hour".
In the case of the example, push the **CHANGE** button to set at "10" and then push the **SET** button.
At that moment, the flashing changes from "Hour" to "Minute".
- 4 In this case, push the **CHANGE** button to set at "00" and then push the **SET** button.

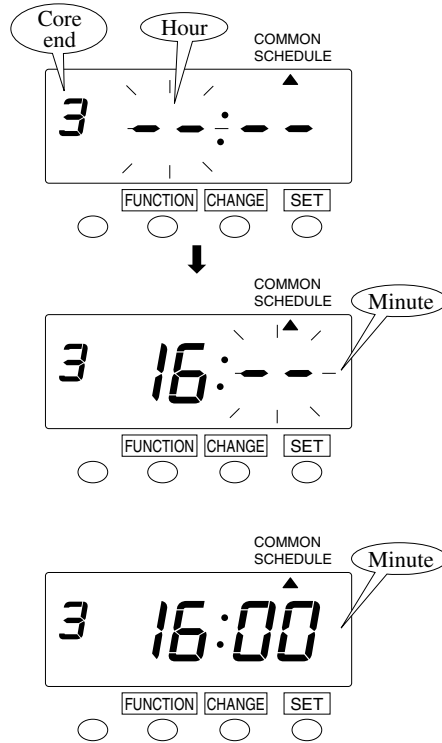

Set the "core end" time.

5 Push the **CHANGE** button twice to set the left-side number at "3" and then push the **SET** button. (In case of "EXTRA", set at "4".) At that moment, the flashing changes to "Hour".

In the case of the example, push the **CHANGE** button to set at "16" and then push the **SET** button.

At that moment, the flashing changes from "Hour" to "Minute".

6 In this case, push the **CHANGE** button to set at "00" and then push the **SET** button.

7 Push the **SET** button once again.

Program List for Setting Schedules

Description	Program No.	
	Common	Extra
Applicable day(s) of the week	-	1
Start time of calculation effective time zone	1	2
Start time of core time for special mark printing	2	3
End time of core time for special mark printing	3	4
End time of calculation effective time zone	4	5
Max in value (= Limit hours for OUT punch)	5	6
Start time of break time-1	6	7
Duration of break time-1	7	8
Start time of break time-2	8	9
Duration of break time-2	9	10
Start time of break time-3	10	11
Duration of break time-3	11	12
Start time of break time-4	12	13
Duration of break time-4	13	14

Rounding

This setting is available only when you use the VN cards WITH calculation.
(Only when you've selected "C1" or "C3" in the "Card Type" setting.)

For Rounding, there are 2 settings: "Types of Rounding" and "Rounding Unit". For "Types of Rounding", there are "Hourly Rounding" and "Punch Time Rounding", and you can choose one.

For "Hourly Rounding", you calculate the hours from time "IN" and time "OUT", and round that result with the "Rounding Unit" that you have selected. The fractions that occur after rounding will be omitted.

For "Punch Time Rounding", the recorder rounds both the time "IN" and "OUT" and then it calculates the hours from the time "IN" and "OUT". When rounding the time "IN", it will raise the fractions that occur. And for the rounding of time "OUT", it will omit the fractions.

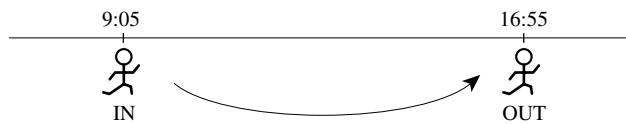

Example: Rounding Unit 15 min.

Types of Rounding	IN	OUT	Total
Hours	9:05	16:55	$16:55 - 9:05 = 7:50 \xrightarrow{\text{round}} 7:45$
Punch time	$9:05 \xrightarrow{\text{round}} 9:15$	$16:55 \xrightarrow{\text{round}} 16:45$	$16:45 - 9:15 = 7:30$

Please go to the next page for setting.

Setting the Rounding

The clock default is "1. hours (Hourly rounding)" and "1min. (exact time)".

Types of rounding	
1	hours (Hourly rounding)
2	punch (Punch time rounding)

Rounding unit								
1min.	3min.	5min.*1	6min.	10min.*1	12min.	15min.	20min.*1	30min.

*1: When you select "Hundredths (1/100)" for the minute print format in the "Print Format" setting, these 3 options can not be selectable.

Example: Type of rounding is the "Punch". Rounding unit is "15 min".

- 1 Push the **FUNCTION** button for 3 seconds.
- 2 Push the **FUNCTION** button and position the "▲" under the "ROUNDING" mark.

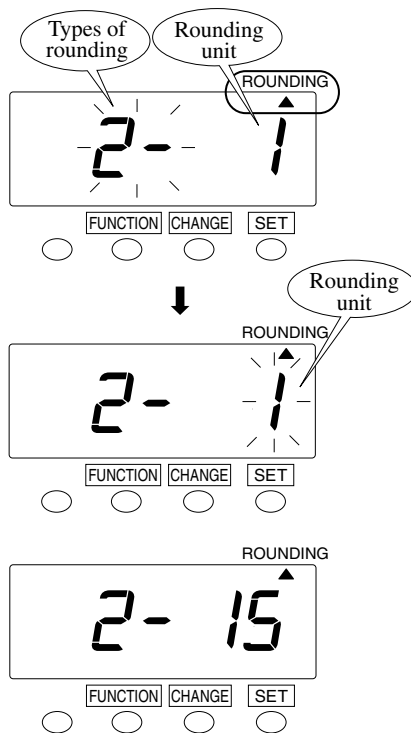

Set the "Types of rounding".

- 3 In the case of the example, push the **CHANGE** button to set at "2" and push the **SET** button. At that moment, the flashing changes from "Types of rounding" to "Rounding unit".

Set the "Rounding unit".

- 4 In this case, push the **CHANGE** button to set at "15" and then push the **SET** button.
- 5 Push the **SET** button once again.

Weekly Program

This setting is available only when you use the VN cards WITHOUT calculation.
(Only when you've selected "C2", "C4", "C5", "C6" or "C7" in the "Card Type" setting.)

Weekly Program enables the clock to memorize the following functions for specified time periods. When the option "C5", "C6", or "C7" is selected in the "Card Type" setting, times are always printed in the 1st column unless any program for print column shift is set.

Up to 48 programs can be set.

Function No.	Function
1	Automatic IN/OUT printing column shift *1
2	Irregular mark "▲" for irregular recognition *2

*1: When you select the option "C2" or "C4" with VN cards in the "Card Type" setting, this function can not be selectable.

*2: When you select the option "5" or "6" in the "Print Format" setting, the irregular mark appears instead of AM/PM indication and will change to "▼" in the afternoon.

== The time table program is explained using the following example. ==

Example

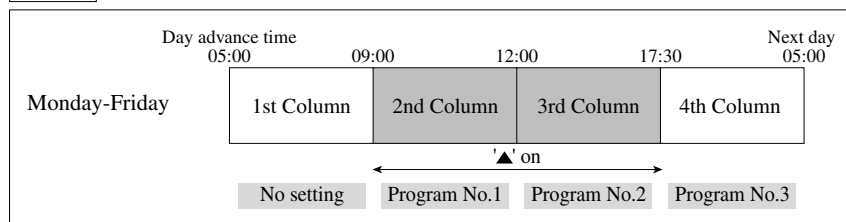

Time table

Program No.	Day of the Week	Time	Print Column	Print Irregular Mark
1	Mon.-Fri.	9:00	2	On
2	Mon.-Fri.	12:00	3	On
3	Mon.-Fri.	17:30	4	Off

Note: One programmed day begins at the day advance time.

Refer to "Setting Day Advance Time" section in this manual.

Setting the Weekly Program

Setting the Weekly Program No. 1

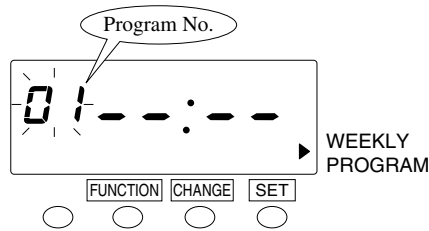

1 Push the **FUNCTION** button for 3 seconds.

2 Push the **FUNCTION** button and position the "▲" next to the "WEEKLY PROGRAM" mark.

Select the Program No.

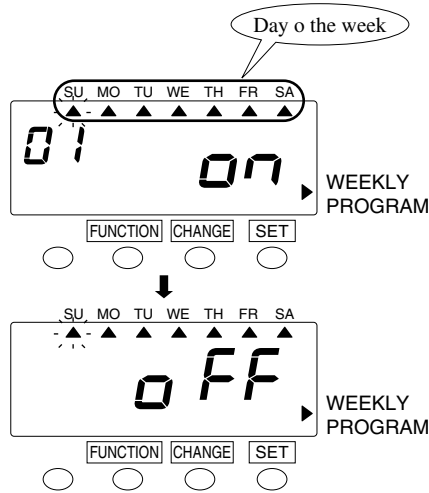

3 Press the **CHANGE** button to change the program No. In case of the example, the "Program No." is not to be changed. Push the **SET** button to accept, and the display will be as shown in the left figure. Now you can set applicable day of the week.

Select applicable "Day of the Week".

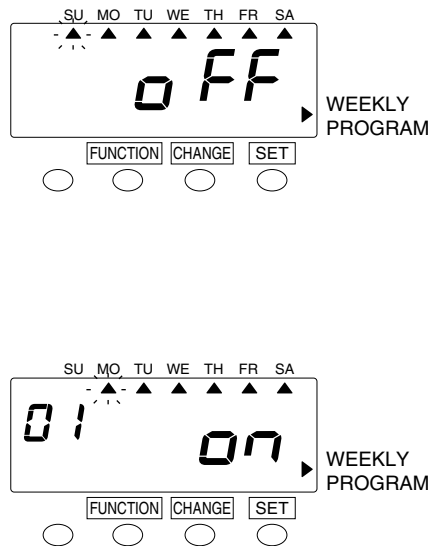

4 Whenever you push the **CHANGE** button, "on" and "off" appears on the display alternately. In case of the example, push the **CHANGE** button to show "off" because the program is not applied to Sunday. Then, push the **SET** button. At that moment, the flashing moves to Monday.

5 While confirming the display shows "on", push the **SET** button to accept, and the flashing on the display moves to Tuesday.

"▲" is lit up after the applicable day of the week is selected.

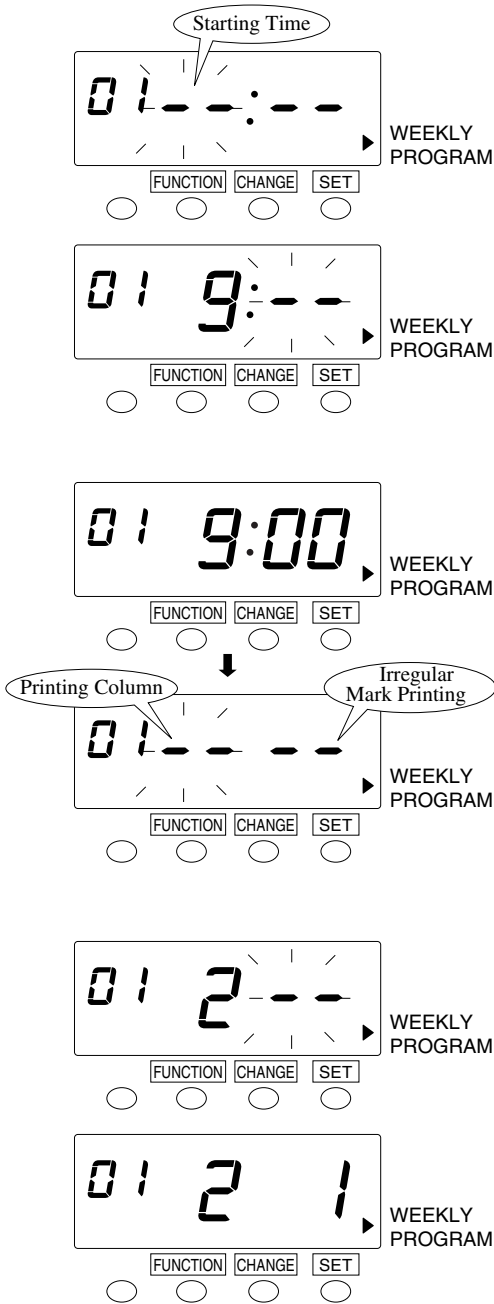

6 Select all applicable days of the week in the same manner as above. When you finish setting, the display changes as shown in the left figure and now you can set the starting time.

Set the Starting Time.

7 In case of the example, push the **CHANGE** button to set at "9" and then push the **SET** button. At that moment, flashing of the display will change from "Hour" to "Minute".

8 In case of the example, push the **CHANGE** button to set at "00" and then push the **SET** button. When you finish setting of the time, the display changes as shown in the left figure and now you can set the desired function.

Select the Desired Function.

9 [For the printing column]

Order Options			
--	Not selected (Remain unchanged)		
1	1st Column	3	1st Column
2	2nd Column	4	2nd Column

In case of the example, push the **CHANGE** button to set at "2" and then push the **SET** button. At that moment, flashing of the display will change from the middle digit to the right-side digit.

[For the Irregular mark printing]

Order Options	
--	Not selected (Remain unchanged)
1	Mark on
2	Mark off

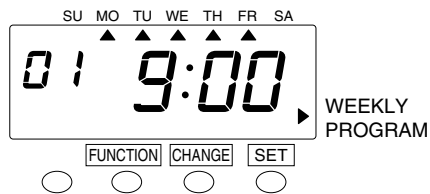

In case of the example, push the **CHANGE** button to set at "1" and then push the **SET** button. At that moment, the display will be as shown in the left figure and the setting of the "Program No. 1" has been completed.

Setting the Program No. 2 & 3

Push the **CHANGE** button and the "Program No." will start flashing.
Push the **CHANGE** button once again to set the Program No. at "2" or "3".

Make settings for the Program No. 2-3 in the same manner as for the Program No. 1.

[Program No. 2]



[Program No. 3]

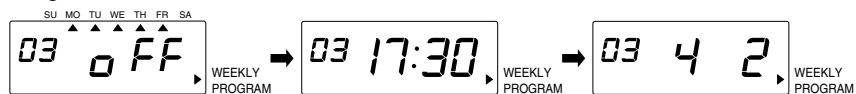

Confirming the Weekly Program

Refer to the previous setting section and confirm the setting by changing the program No.

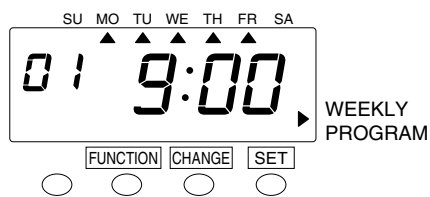

With the corresponding program No., you can check the applicable days of the week and starting time on the display. To confirm setting details on the display, take the same procedures for setting.

If you want to confirm all detailed settings in one time, printing list of program setting is available.
Refer to "Printing List of Setting Information and Active Cards" in "7. ADDITIONAL FUNCTIONS".

Changing the Weekly Program

Refer to the previous setting section and select the program No. by pushing the **CHANGE** button, which you want to change. Once the desired program No. starts flashing, push the **SET** button and change settings in the same manner as you originally set.

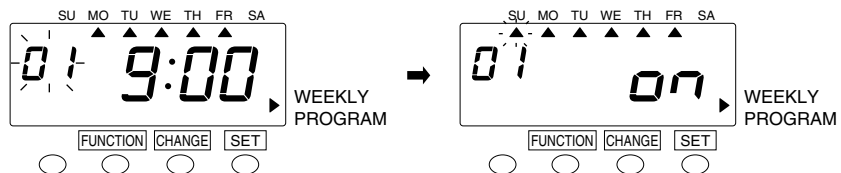

Deleting the Weekly Program

Refer to the previous setting section and select the program No. by pushing the **CHANGE** button, which you want to delete. Once the desired program No. starts flashing, push the **SET** button and set "off" for all the days of the week. At that moment, the display will be as shown in the following figure and now the program is deleted.

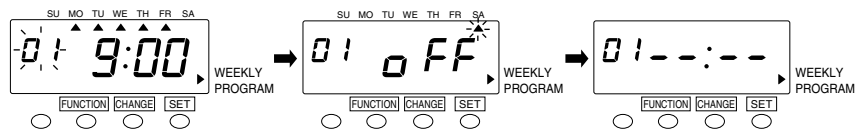

Setting the Password

Once the password is set, you are requested to enter the current password before changing any setting. If the password you entered does not coincide with the setting, you cannot change the setting values.

You can select any 4-digit number from 0001 to 9998 as your password.

Note: Numbers "0000" and "9999" are not valid as password.

Example: Set the password "1234".

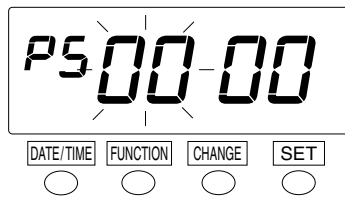

- 1 Push the **DATE/TIME** button and the **FUNCTION** button at the same time for 3 seconds. Then, the display changes and shows "PS" on the upper left and you can set a password.

The flashing number can be changed.

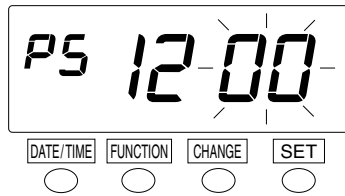

- 2 **Set the first two digits.**

In case of the example, push the **CHANGE** button to set at "12" and then push the **SET** button. At that moment, the flashing will change to the last two digits.

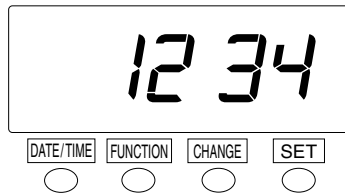

- 3 **Set the last two digits.**

Next, push the **CHANGE** button to set at "34" and then push the **SET** button. At that moment, the display will stop flashing, and the setting is now completed.

- 4 Push the **SET** button once again.

How to Change Settings When the Password Is Set

Once the password is set, you are requested to enter the current password before changing any setting.

Example: The current password is "1234" and go into the "FUNCTION" setting mode.

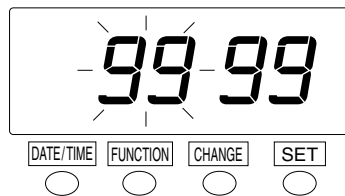

- 1 Push the **FUNCTION** button for 3 seconds. Then, "9999" will be indicated on the display and the first two digits flash.

The flashing number can be changed.

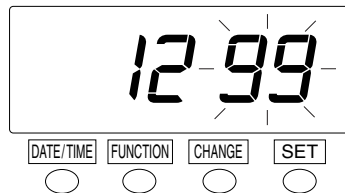

- 2 **Enter the first two digits.**

In case of the example, push **CHANGE** button to set at "12" and then push the **SET** button. At that moment, the flashing will change to the last two digits.

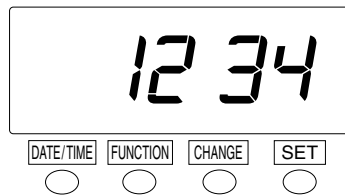

- 3 **Enter the last two digits.**

In case of the example, push the **CHANGE** button to set at "34" and then push the **SET** button. At that moment, the "▲" mark is located under "CARD TYPE".

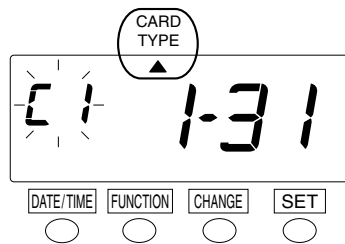

- 4 Select desired setting mode by pushing the **FUNCTION** button. Then make any changes as explained.

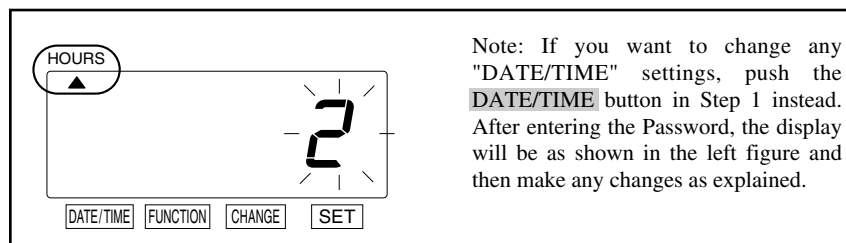

Note: If you want to change any "DATE/TIME" settings, push the **DATE/TIME** button in Step 1 instead. After entering the Password, the display will be as shown in the left figure and then make any changes as explained.

Canceling the Password

To cancel the Password, the current one must be changed to "0000".

Example: The current password is "1234" and cancel it

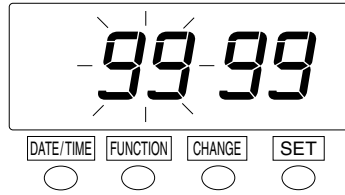

- 1 Push the **DATE/TIME** button and the **FUNCTION** button at the same time for 3 seconds. Then, enter the password.

For entering password, refer to Step 2 and 3 in "How to Change Settings When the Password is Set" (on the previous page).
The flashing number can be changed.

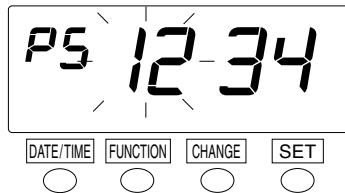

- 2 When the password is accepted, the display changes and shows "PS" on the upper left. At that moment, the first 2 digits of the current password "12" starts flashing.

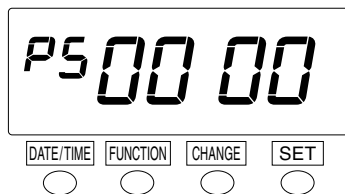

- 3 Push the **CHANGE** button to set at "00" for all digits and then push the **SET** button. At that moment, display stop flashing and the setting is now completed.

- 4 Push the **SET** button again.

7. ADDITIONAL FUNCTIONS

Resetting

To return all settings to their factory defaults.

Please note that all settings will be deleted and will revert to the factory defaults when the reset switch is pushed. To make new settings, please refer to "5. BASIC SETTINGS" and "6. ADVANCED SETTINGS".

Stored cards are also deleted from memory. (Only for VN card users)

If you want to just reset all cards, refer to "All Cards Resetting" in the following pages of this section. (Only for VN card users)

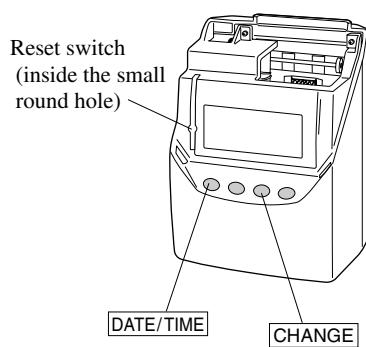

1 Push the reset switch with a pointed implement while pushing the **DATE/TIME** and **CHANGE** button.

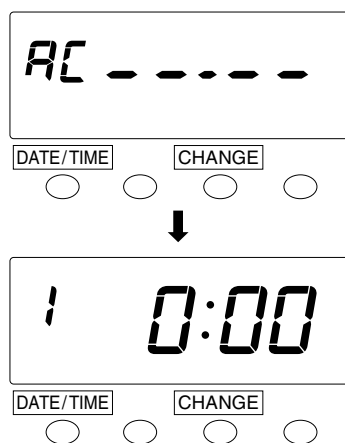

2 At that moment, the display change to AC " - - - - - ".
And after a few seconds, the display changes to date & time "1 0:00".

Card Reassign (Only for VN card users)

When the card that you are using becomes full before reaching the "Pay Period" day, it will show "End" on the display and the buzzer will sound. When the "End" appears, you can use the "Card reassign" mode to transfer the card and have a new card take over from the old one.

In this function, it will be useful :

- when the card has become full before reaching the "Pay Period".
- when the card that is lost or damaged.

You can transfer the old card to a new one with the same number or the one which is not used in the current pay period. If you are already using all time cards from No. 1 to 100, you can transfer the card only to the new one with the same card number. If you prefer to use another time card with a different number, you must reset the corresponding card first.

Example

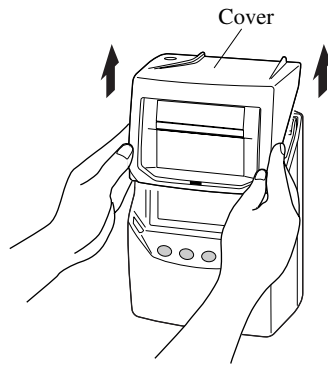
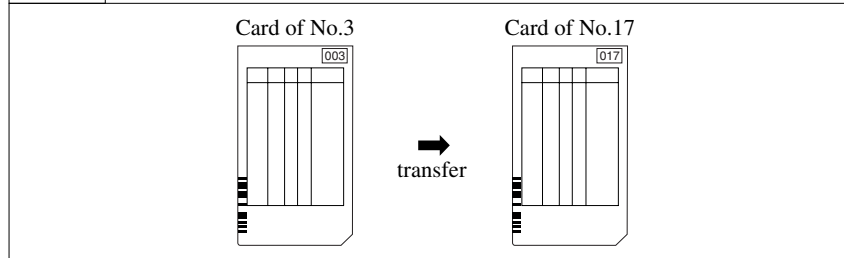

1 Remove the cover.

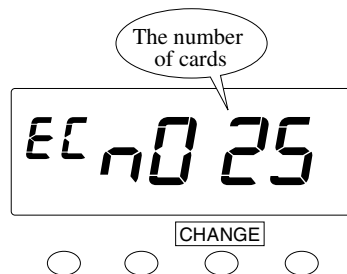

2 Push the **CHANGE** button for 3 seconds.

When you have a card that you are using, the number of cards that you are using will be shown on the display. If there are no cards used at the present state, it will show "n000" and will end the mode.



CHANGE SET

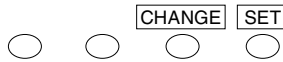
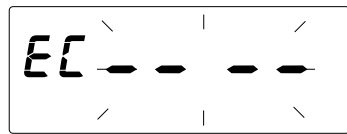

CHANGE SET

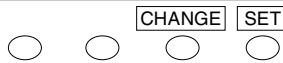

CHANGE SET

- 3 After the numbers of cards are shown, in the example, insert the card "003" or push the **CHANGE** button to show the card number "003" and then push the **SET** button.

- 4 Next insert the card "017" or push the **CHANGE** button to pick a new card number "017" and then push the **SET** button.

When the card number is changed, this mode will finish.

All Cards Reset (Only for VN card users)

You want to reset all cards manually.....

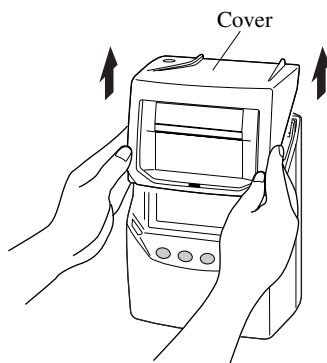

- 1 Remove the cover.

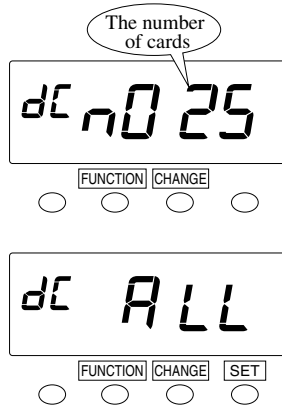

2 Push the **FUNCTION** and **CHANGE** button for 3 seconds. The number of cards that you are using will be shown on the display.

3 Push the **CHANGE** button to show "ALL" and then push the **SET** button.

4 Push the **SET** button one more time.

Card Reset (Only for VN card users)

If you want to reset the card manually before the end of pay period, you can use the "Card reset" mode.

Example: The number of the card you want to reset is "003".

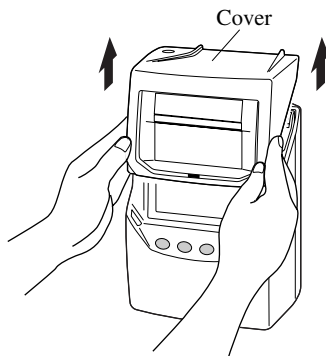

1 Remove the cover.

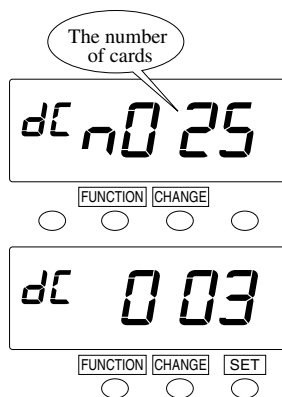

2 Push the **FUNCTION** and **CHANGE** button for 3 seconds. The number of cards that you are using will be shown on the display.

3 In the example, insert the card "003" or push the **CHANGE** button to show the card number "003" and then push the **SET** button.

4 Push the **SET** button.

Printing List of Setting Information and Active Cards

Setting Information

With this function, you can check what rules are currently set in the clock.

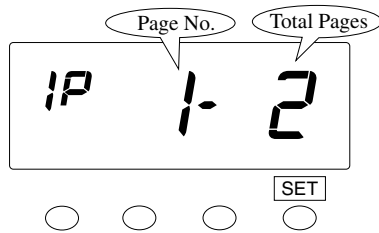

- 1 Push the **SET** button for 3 seconds.
At that moment, "IP" is indicated on the upper left of display.
- 2 Insert a blank time card and a list is printed out.

Note: After completing printing the list, the display automatically returns to normal clock indication.

Active Cards in the Current Pay Period

With this function, you can check which numbers of time cards are used in the current pay period.

This function is available only when you've selected "C1", "C2", "C3", or "C4" in the "Card Type" setting. (Only for VN card users)

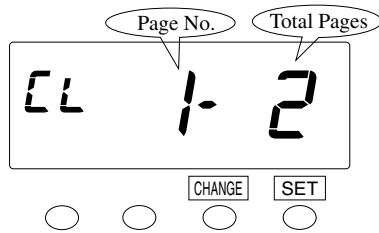

- 1 Push the **CHANGE** button and the **SET** button at the same time for 3 seconds.
At that moment, "CL" is indicated on the upper left of display.
- 2 Insert a blank time card and a list is printed out.

Note: If no card is used in the current pay period, the display automatically returns to normal clock indication in 3 seconds.

8. INSTALLING THE BATTERY (OPTIONAL)

Follow the steps below to install a battery (optional) so that the clock would be operational during a power failure.

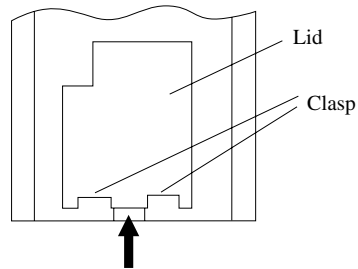

- 1 Remove the lid of the battery compartment on the back of the unit by pushing up the center of the lid, and then release it from the two clasps.

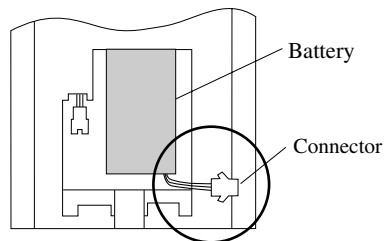

- 2 Position the battery as shown in the figure on the left .
* The connector cord should be on the right side, as shown in the figure.

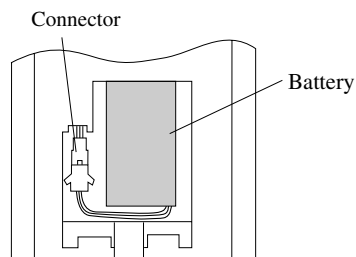

- 3 Connect the connector. Tuck away the connector cord into the open space in the compartment.

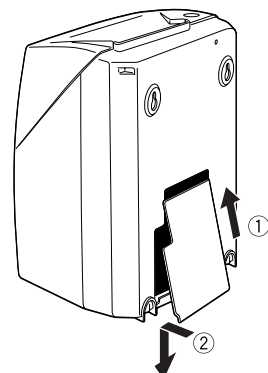

- 4 Insert the lid into the slot as shown on the left. Keep pressing it down until it hooks to the clasp.
* Make sure the cord is not caught when closing the lid.

9. TROUBLESHOOTING

Error No. Causes and Actions

No.	Error causes	Action
E-00	CPU Error	Contact the store from whom whom you bought the unit.
E-01	The remaining life of lithium battery for memory back-up is short.	
E-03	Card inserted on wrong side.	Correctly insert the time card.
E-04	Inserted time card was wrong type.	Check the correct card type is selected in "Card Type" setting.
E-05	The card is not pulled in properly.	Make sure that another time card is not jamming in the time recorder. Try inserting the time card again.
E-15	Card sensor error	
E-10	RAM error	Contact the store from whom whom you bought the unit.
E-12	Clock does not work.	
E-14		
E-16	Memory error for reading or writing the calculated data	Try inserting the time card again or another time card. If the error number continues to be displayed, contact the store from whom you bought the unit.
E-18		
E-17	Memory format error	Use the "Resetting" function to reset all settings. If the error number continues to be displayed, contact the store from whom you bought the unit.
E-30	The printer motor or the sensor is not normal.	Make sure that another time card is not jamming in the time recorder and the ribbon cassette is correctly inserted in place.
E-37	The card forwarding motor or the sensor does not operate properly.	After making sure of the above, close the cover. If the error number continues to be displayed, contact the store from whom you bought the unit.
E-38	The print head motor or the sensor for the print head can not operate properly.	
E-40	Password error	Input the correct password you set. (4-digit numbers)
E-41	The start date and the end date of the daylight saving time are the same date.	Correctly set the daylight saving time.
E-49	Input the wrong settings.	Check the setting contents and input the correct figures.

Error No. Causes and Actions (continued)

No.	Error causes	Action
E-50	Can't use the time card.	Check to make sure the barcode area of the card is not smudged or damaged.
E-51	Punch error (punch time error)	Check whether the time was turned back or not.
E-52	Punch error (punch logic error)	Check whether the day's last column was already used when you use the time card with "line per day". Also check whether you can print if you change a time card or the day changes.
E-59	Can't use the time cards because of memory error.	Use the "Card Reset" function to reset the card. Make sure if you can print by inserting the time card with the same number.
End	When the card that you are using becomes full before reaching the "pay period ending date/day".	Use the "Card Reassign" mode to transfer the card and have a new card take over for the old one.

* If the error number is still displayed after checking above points, contact the store from whom you bought the unit.

Other failures

- **The unit does not operate.**

Check whether the power cord is properly in an AC outlet.

- **The unit does not print.**

Check whether the ribbon is installed in place.

- **Print is not located in the right place.**

Check whether the setting of the pay period ending date is set correctly.

Check whether the day advance time is set correctly.

Make sure that no part of the time card is folded, and that the time card is inserted straight into the unit.

→ If improper printing still remains after checking above points, contact the store from whom you bought the unit.

- **"99 99" appears when you try to get into the setting mode.**

Password is required. Input the correct password you've set. (4-digit numbers)

→ See "How to Change Settings When the Password Is Set" in this manual.

10. SPECIFICATIONS

Clock accuracy	Monthly accuracy $\pm 15s$ (at ordinary temperature)
Calendar	Year up to 2099. Automatically adjusted to leap years, 31-day months and months with thirty or fewer days, and the days of the week.
Printing system	Dot matrix
Power failure compensation	Three years of cumulative power failure hours after the date of shipment
Print at power failure	Optional battery, 100-time printing or 24 hours
Memory capacity	100 employees capacity (with VN card)
Operating environment	Temperature: -5° to $+45^{\circ}C$: $+23^{\circ}$ to $+113^{\circ}F$ Humidity: 20 to 80%RH, no condensation The unit operates normally at temperatures of $5^{\circ}C$ or below, but the print density, reaction of the liquid crystal display, and the number of prints at power failure are inferior to those at normal temperature operation.
Dimensions	6.3" (w) x 8.07" (h) x 5.04" (d) 160 (w) x 205 (h) x 128 (d) mm
Weight	Approx. 3.3lbs. (1.5kg)
Rating	120VAC 50/60Hz 0.3A 220-240VAC 50/60Hz 0.17A

11. TIME CARD SPECIFICATIONS

(1) VN Card

Monthly/Weekly/Bi-Weekly, both sides, with barcode

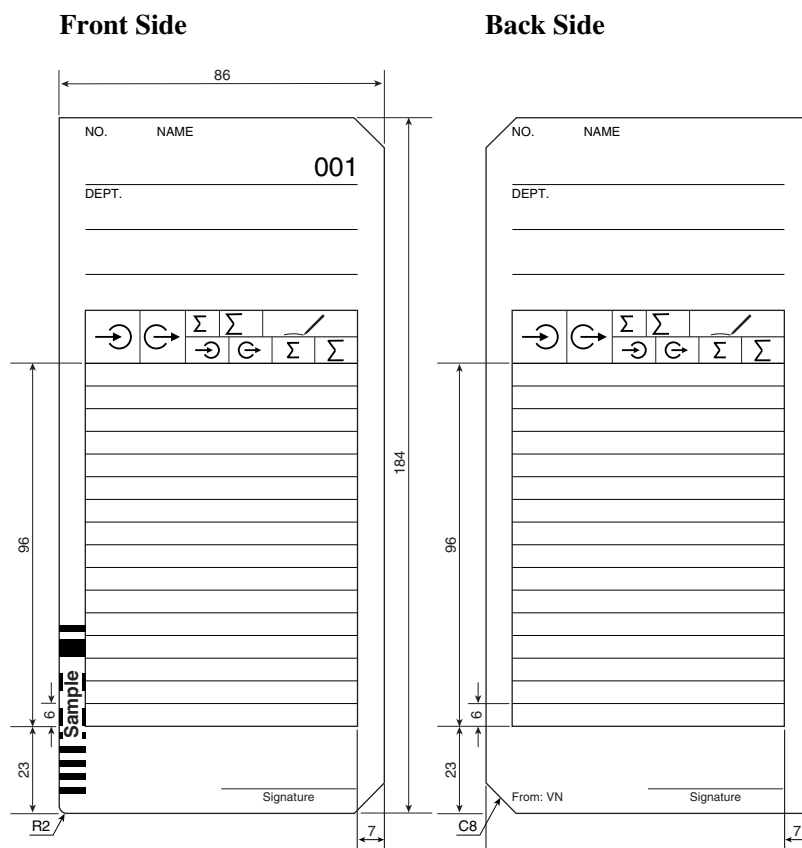

Unit: mm

Note

Recommended Paper Thickness : $0.40 \pm 0.05\text{mm}$

(2) S Card

Monthly, both sides

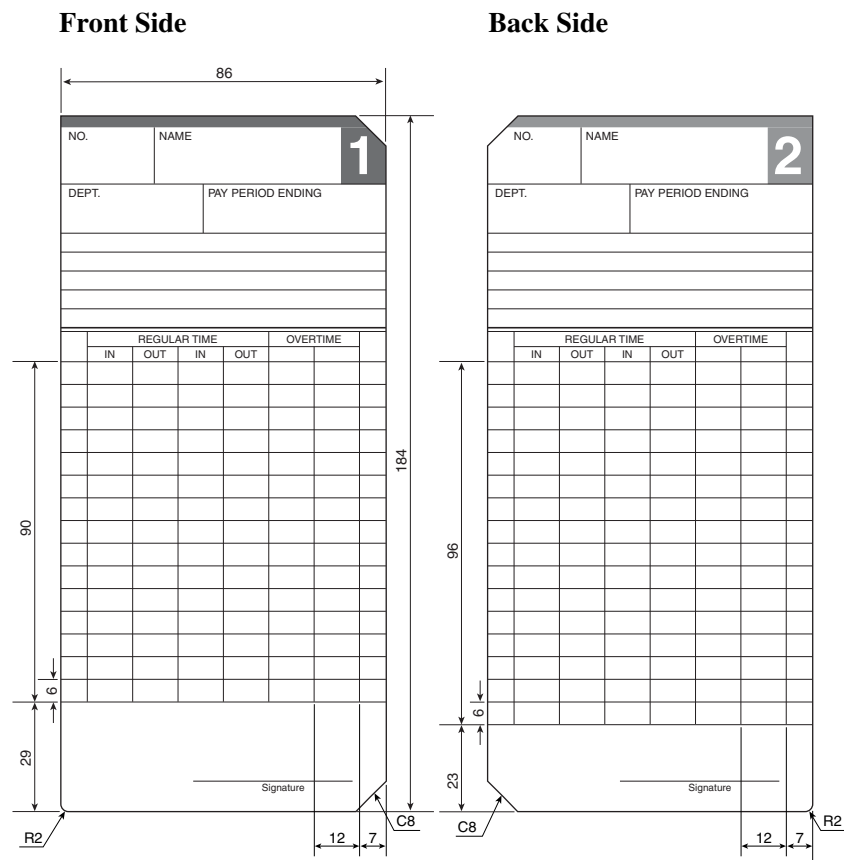

Unit: mm

Note

Recommended Paper Thickness : 0.45 ± 0.05 mm

(3) Weekly Card
Weekly, one side

(4) Bi-Weekly Card
Bi-weekly, one side

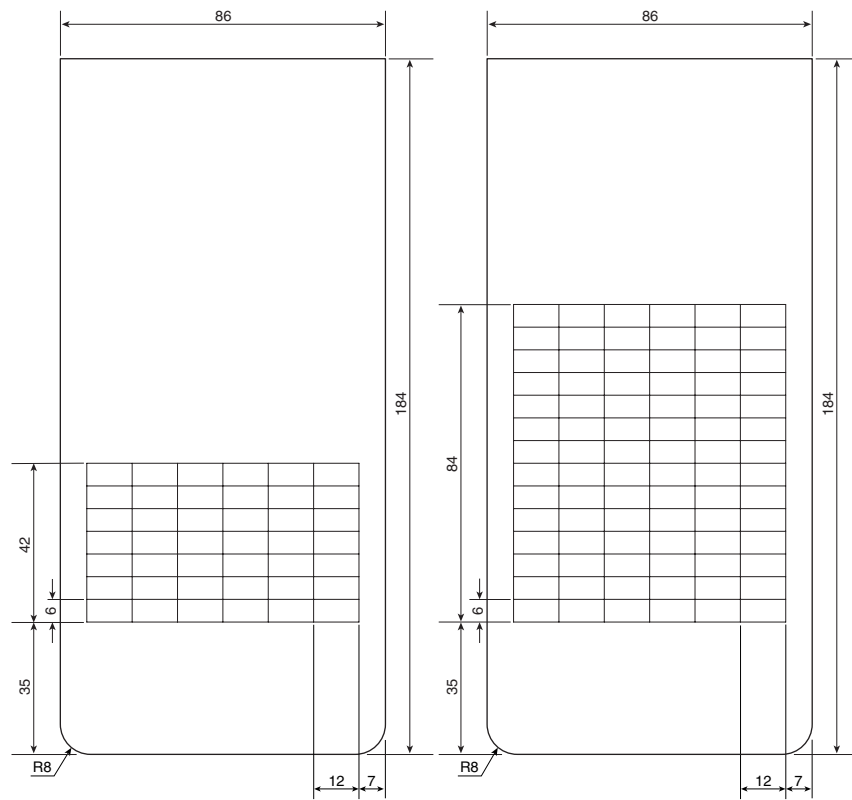

Unit: mm

Note

Recommended Paper Thickness : 0.45 ± 0.05 mm

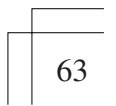
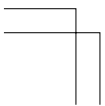
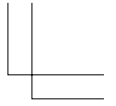
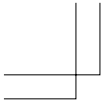

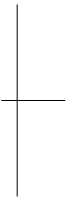
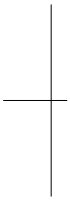
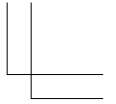
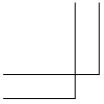

SEIKO PRECISION INC.

ALL RIGHTS RESERVED
©2012 SEIKO PRECISION INC.

Q0285-61200

