

QUARTZ TIME RECORDER

QR-6550/6560

USER'S MANUAL

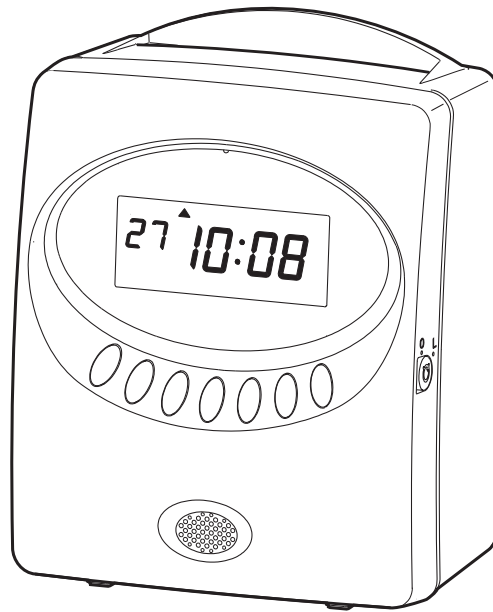

SEIKO Precision

INTRODUCTION

Thank you for purchasing our Quartz Time Recorder. For safe and proper operation, please carefully read this manual before using it and save it for reference.

Bescheinigung des Herstellers/Importeurs

Dieses Gerät entspricht den Bedingungen der Niederspannungs-Vorschrift 73/23/EEC und dem EMVG nach 89/336/EEC.

This unit complies with the Low Voltage Directive 73/23/EEC and the EMC Directive 89/336/EEC.

Maschinenlärminformations-Verordnung 3. GPSGV:

Der höchste Schalldruckpegel beträgt 70 dB (A) oder weniger gemäß EN ISO 7779.

Die zugehörige Steckdose muß nahe beim Gerät angebracht und leicht zugänglich sein.

1. The details of this User's Manual are subject to change without previous notification.
2. This User's Manual has been prepared with the utmost care to cover all aspects of the time recorder's use.
If you feel, however, that some explanations are inadequate, unclear, or difficult to understand, please do not hesitate to contact the dealer or the shop from which you have purchased your Time Recorder.
3. Be sure to use your Time Recorder after you have fully understood the hardware and software specifications and limits.
4. No part of this publication may be reproduced, stored in a retrieval system, or transmitted, in any form or by any means, mechanical, photocopying, recording or otherwise.
 - Place the time recorder at the position close to the wall outlet so that it is easily accessible to disconnect.

Die in dieser Bedienungsanleitung enthaltenen Angaben können jederzeit ohne vorherige Ankündigung geändert werden.

Diese Bedienungsanleitung wurde mit äußerster Sorgfalt erstellt, um alle Einzelheiten hinsichtlich der Bedienung des Zeiterfassungsgerätes darzustellen. Sollten Sie dennoch Fragen haben oder Fehler in der Anleitung entdecken, nehmen Sie bitte mit uns Kontakt auf.

Wir haften nicht für direkte oder indirekte Schäden, die durch die Verwendung dieser Betriebsanleitung entstehen.

Lesen Sie diese Anleitung aufmerksam und benutzen Sie Ihr Zeiterfassungsgerät erst dann, wenn Sie die Angaben über die Hardware und Software richtig verstanden haben.

TABLE OF CONTENTS



1. PRECAUTIONS	1
2. FEATURES	5
Environmental Conditions	5
3. GETTING STARTED	6
Unpacking the QR-6550 / 6560	6
Overview	6
Installing Ribbon Cassette	7
4. OVERVIEW OF OPERATION	9
5. SETTINGS	11
Preparation for Settings	11
Overview of Control Buttons	12
Selecting the Hour Display Format	13
Setting the Time	14
Setting the Date	15
Selecting the Card Type	16
Setting Pay Period Ending Date/Day	18
Monthly / Weekly / Bi-weekly	18
Setting the Day Advance Time	21
Selecting the Print Format	22
Selecting the Language	23
Setting the Daylight Saving Time	24
Deleting the Daylight Saving Time Settings	27
Setting the Weekly Program	28
Confirming the Weekly Program	38
Changing the Weekly Program	38
Deleting the Weekly Program	38
Setting Duration of External Time Signal (QR-6560)	39
Selecting Volume of Melodies (QR-6560)	40
Setting the Password	41
How to Change Settings When the Password Is Set	42
Canceling the Password	43
6. PRINTING LIST OF SETTING INFORMATION	44
7. RESETTING	46
Card Resetting (QR-6560)	47
8. MOUNTING UNIT ON WALL	48
9. INSTALLING THE OPTIONAL BATTERY BACK-UP	49
10. CONNECTING EXTERNAL TIME SIGNAL	50
11. TROUBLESHOOTING	52
12. SPECIFICATIONS	54
13. TIME CARD SPECIFICATIONS	56
Template for wall mounting	61





1. PRECAUTIONS







This operation manual is prepared for safe and proper use of the unit. Please follow all the instructions to avoid possible danger to yourself or others and damage to the unit.

Signs

Various warnings and cautions are provided throughout this manual along with signs. Remember each sign and its explanation listed below for your safety and proper operation of the unit.

	Warning	Improper handling may cause bodily accidents including death and serious injury.
	Caution	Improper handling may harm the human body or material.

	Improper handling may cause electric shock DANGER.		"Must-Do" sign.
	DO NOT disassemble the unit.		Be sure to remove the line cord plug from the outlet.
	"Don't" sign.		

 Warning	
	Do not disassemble the unit. There is a high voltage present inside, possibly leading to an electric shock.
	Do not modify the unit. Modifications may cause a fire and/or electric shock.
	If any anomaly occurs, for example, heat or smoke is generated or an odor is emitted, unplug the unit immediately and contact your dealer for servicing. There is a danger that further use may cause a fire or electric shock.
	Do not use any voltage of the power source other than designated. Do not share a single outlet with another plug. These may lead to fire or shock hazards.
	Do not damage, break, or modify the power cord. Do not put a heavy object on, pull, or forcefully bend the cord, either. These may damage the cord, possibly resulting in a fire or electric shock.

 If foreign matter should get in the unit (including a piece of metal, water, or liquid), disconnect the plug from the outlet immediately and contact your dealer for servicing. There is a danger that further use may cause a fire or electric shock.

 Do not plug or unplug the unit with a wet hand. You may get an electric shock.

 **Caution**

 Do not place the unit on an uneven or tilted surface. This may result in injuries due to the unit dropping or falling off.

 Do not put a water-filled container or a metal object on top of the unit. If water is spilled or the metallic object slips inside, a fire or shock hazard may occur.

 Do not install the unit in a humid or dusty environment. It may cause a fire or electric shock.

 Do not place the unit near kitchen counter or humidifier. Oil, smoke, or steam generating from them may cause fire or shock hazards.

 Do not yank the power cord to disconnect from the outlet. Hold the plug with your hand to do so, or the cord may be damaged, possibly leading to a fire or electric shock.

 Remove the line cord plug from the outlet before transferring the unit, or it may damage the cord, possibly leading to a fire or electric shock.

 Be careful not to contact the print head, as you may get hurt or burned.

 Make sure to insert the power plug as far as it will go. Improper insertion of the plug may develop fire or shock hazards.

 Do not insert or drop any other time card than specified into the slot. Such misuse may cause a fire or electric shock.

 If the unit should be dropped or the case be broken, unplug the unit and contact your dealer for servicing. Further use may lead to a fire or shock hazard.



Daily Care
For cleaning, turn the power off and wipe the case clean of dust and dirt with a dry cloth, etc.





Vorsichtsmassnahmen







Dieses Bedienerhandbuch stellt die sichere und ordnungsgemäße Verwendung des Geräts sicher. Befolgen der Anweisungen schützt den Bediener und andere vor Verletzungen und verhindert die Beschädigung des Geräts.



Warnschilder

Nachfolgend werden Schilder mit Warn- und Vorsichtshinweisen dargestellt. Um das Gerät sicher und ordnungsgemäß handhaben zu können, hat sich der Bediener jedes Schild und die nachstehende Erklärung zu beachten.

	Achtung	Unangebrachte Handhabung kann zu Unfällen mit ernststen und tödlichen Körperverletzungen führen.
	Vorsicht	Unangebrachte Handhabung kann zu Körperverletzungen oder Sachschäden führen.

	Unangebrachte Handhabung kann zu GEFAHREN wie elektrischen Schlag führen.		Das Schild weist auf unbedingt erforderliche Handlungen hin.
	Das Gerät NICHT auseinandernehmen.		Den Stecker des Anschlußkabels aus der Netzsteckdose ziehen.
	Das Schild weist auf zu unterlassende Handlungen hin.		

		Achtung
	Das Gerät nicht auseinandernehmen. Die hohe Spannung im Gehäuse könnte zu einem elektrischen Schlag führen.	
	Das Gerät nicht umbauen. Änderungen könnten ein Feuer verursachen und/oder zu einem elektrischen Schlag führen.	
	Tritt ein abnormaler Zustand ein, das Gerät wird z.B. heiß, raucht oder ein Geruch macht sich bemerkbar, sofort den Stecker aus der Netzsteckdose ziehen und den Kundendienst des Händlers benachrichtigen. Die weitere Verwendung könnte ein Feuer verursachen oder zu einem elektrischen Schlag führen.	
	Das Gerät nur an eine Stromquelle mit der vorgeschriebenen Spannung anschließen. Anschluss von zwei Geräten an eine Netzsteckdose vermeiden, da dies ein Feuer verursachen oder zu einem elektrischen Schlag führen könnte.	
	Das Anschlusskabel vor Beschädigung oder Bruch schützen und auf keine Weise ändern. Ferner keine schweren Gegenstände auf das Kabel stellen und jegliches ziehen oder knicken des Kabels unterlassen. Das Kabel wird dadurch beschädigt und könnte ein Feuer verursachen oder zu einem elektrischen Schlag führen.	

	Geraten Fremdkörper (einschließlich Metallstücke, Wasser oder sonstige Flüssigkeiten) in das Gerät, sofort den Stecker aus der Netzsteckdose ziehen und den Kundendienst des Händlers benachrichtigen. Die weitere Verwendung könnte ein Feuer verursachen oder zu einem elektrischen Schlag führen.
	Den Stecker des Geräts nicht mit nassen Händen in die Netzsteckdose einstecken bzw. herausziehen, da dies zu einem elektrischen Schlag führen könnte.

 Vorsicht	
	Das Gerät nicht auf eine unebene oder schräge Oberfläche zu stellen. Das Gerät könnte nach unten rutschen bzw. fallen und zu Verletzungen führen.
	Die Oberfläche des Geräts nicht zum Abstellen von Wasserbehältern oder Metallgegenständen verwenden. Wenn verschüttetes Wasser eindringt oder ein Metallgegenstand in das Gerät fällt, kann dies ein Feuer verursachen oder zu einem elektrischen Schlag führen.
	Das Gerät nicht in einer feuchten oder staubigen Umgebung installieren, da dies ein Feuer verursachen oder zu einem elektrischen Schlag führen könnte.
	Das Gerät nicht in der Nähe einer Küchenanrichte oder eines Befeuchters installieren. Das dort vorhandene bzw. erzeugte Öl, Rauch oder Dampf kann ein Feuer verursachen oder zu einem elektrischen Schlag führen.
	Das Anschlusskabel nicht mit Gewalt aus der Steckdose ziehen, sondern mit der Hand entfernen. Beschädigung des Kabels könnte ein Feuer verursachen oder zu einem elektrischen Schlag führen.
	Bei Umstellen des Geräts den Stecker des Anschlusskabels aus der Netzsteckdose ziehen. Beschädigung des Kabels könnte ein Feuer verursachen oder zu einem elektrischen Schlag führen.
	Berühren des Druckkopfes vermeiden, da dies zu Verletzungen oder Verbrennungen führen könnte.
	Den Netzstecker ganz einstecken. Unangebrachtes Einstecken des Netzsteckers kann ein Feuer verursachen oder zu einem elektrischen Schlag führen.
	Nur die vorgeschriebenen Stempelkarten verwenden. Die Verwendung unangebrachter Karten kann ein Feuer verursachen oder zu einem elektrischen Schlag führen.
	Fällt das Gerät oder wird das Gehäuse beschädigt, den Netzstecker herausziehen und den Kundendienst des Händlers benachrichtigen. Die weitere Verwendung könnte ein Feuer verursachen oder zu einem elektrischen Schlag führen.

Tägliche Pflege	
Das Gerät ist bei der Reinigung abzuschalten und mit einem trockenen Tuch von Staub und Schmutz zu befreien.	

2. FEATURES

FEATURES	QR-6550	QR-6560
Up to 6 columns	Yes	Yes
Weekly Program P.28 ~		
Up to 48 programs can be set	Yes	Yes
Automatic IN/OUT printing column shift	Yes	Yes
2-color print: black or red	-	Yes
Special mark "▲" for irregular recognition	Yes	-
Output signal for external chimes	-	Yes
Built-in melody (5 melodies)	-	Yes
Card Type P.16 ~		
Selectable various card formats	Yes (5 types)	Yes (6 types)
Automatic IN/OUT printing column shift by V/VN card (Up to 100 cards can be used for one period.)	-	Yes
Others		
Languages in English, Spanish, German, French, Italian or Portuguese (P.23)	Yes	Yes
Optional battery back-up system providing time keeping and printing operation during power failures (P.49)	Yes	Yes

Environmental Conditions

Avoid placing the unit in such places as:

- is humid or dusty;
- is exposed to direct sunshine;
- vibrates often or all time;
- is outside the temperature range between -5°C and 45°C;
- is affected by chemicals or ozone.

3. GETTING STARTED

Unpacking the QR-6550 / 6560

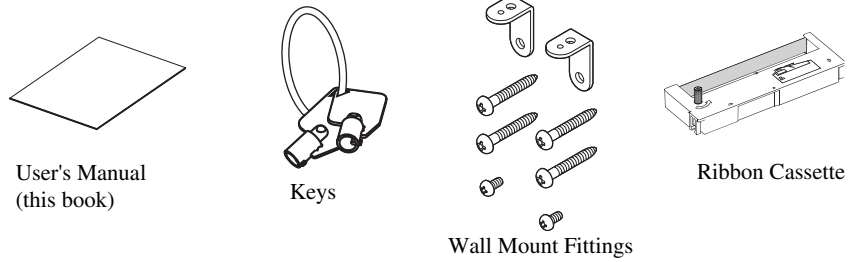

Overview

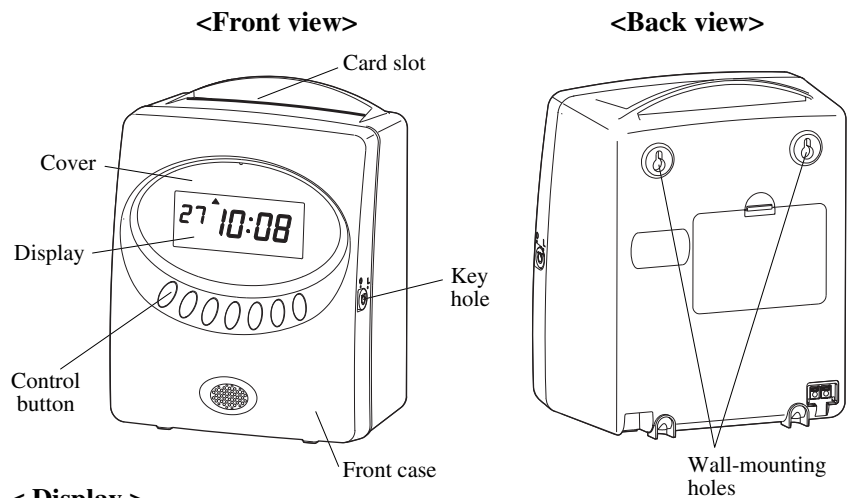

< Display >

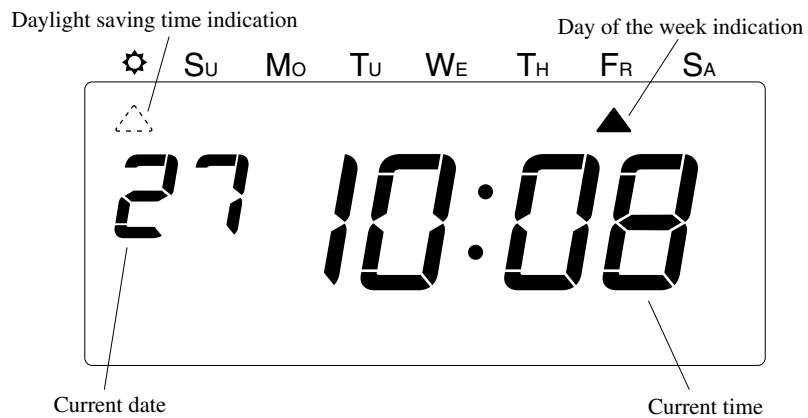

Installing Ribbon Cassette



Please do not turn the key while the front case is open.
Please do not move print head with your hand unnecessarily, and do not touch cables when you install the ribbon. It might cause a malfunction of the unit.



Make sure the power is on before installing.

- 1** While pushing, turn the key to "O" position, and open the front case.

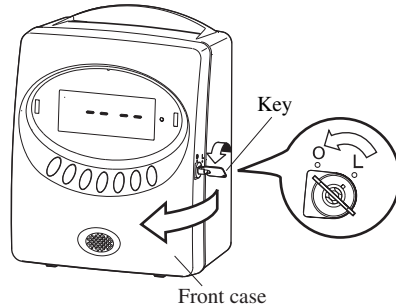

- 2** Turn the knob on the cassette in the arrow-indicated direction to make the ribbon taut.

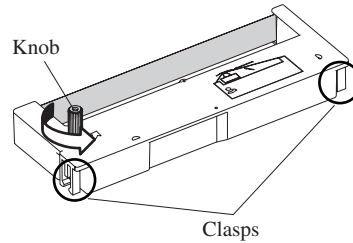

- 3** To insert the cassette inside the unit, thread the ribbon between the ribbon mask and the print head.

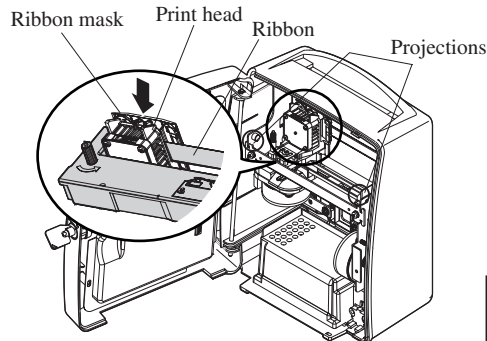

- 4** Slide the clasps on the lower side of the cassette into projections on the unit. Keep pushing the cassette until the clasps catch and snap into position.

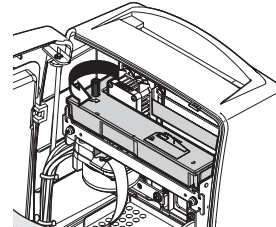

Point If it is difficult to insert the ribbon cassette, try it while turning the knob.



Precautions for inserting a new ribbon cassette

The ribbon should be between the print head and the ribbon mask. Printing failure may occur if the ribbon is placed behind the ribbon mask.

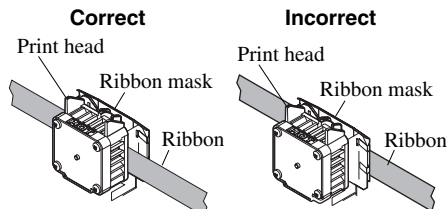

5 Turn the knob of the cassette in the counter clockwise to tighten the ribbon.

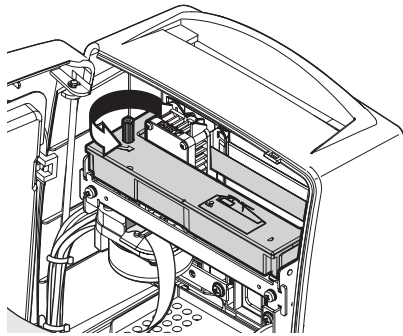

6 Close the front case, and turn the key to "L" position. Make sure "date" and "time" are indicated on the display and "colon" is flashing.

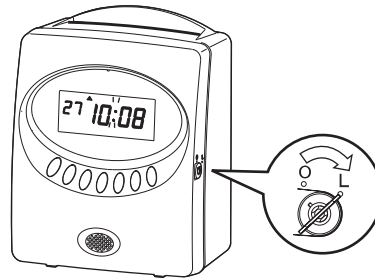

When the flat cable connected to the print head comes off from the holder, please set the cable as shown in the following figure. The flat cable might be damaged when the unit is used with the cable coming off.

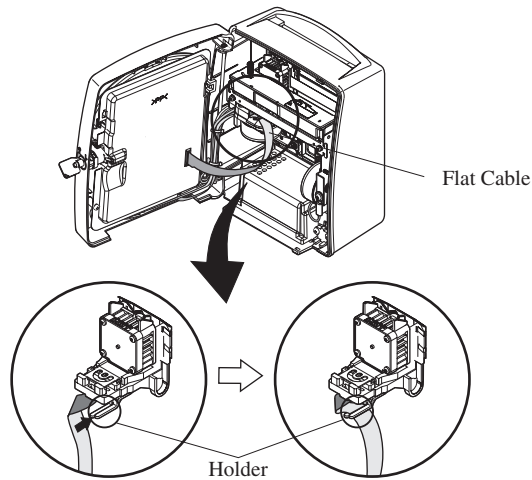

Ribbon cassette Print head

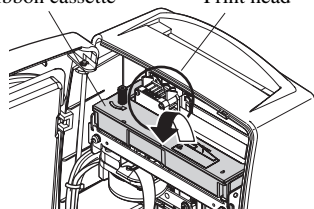

Point How to remove the ribbon cassette

Hold the center of the cassette, lift it from the back, and then pull it toward you.

4. OVERVIEW OF OPERATIONS

Once the AC line code is plugged into the outlet, the unit can be used immediately.



Please refer to "3. GETTING STARTED" section before you start.

It is easy to operate the unit. Just insert a time card. The card is then automatically pulled in, printed and then ejected.



Do not let any metallic object get into the slot, including paper clips. Do not forcefully push in a card, either. These may cause the unit to malfunction.



If any setting needs to be changed, such as for a pay period ending date or other items, refer to "5. SETTINGS".

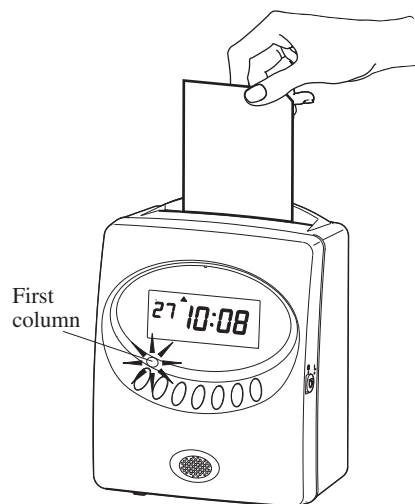

The clock can print time on the column under flashing lamp.

Note The clock prints on the first column when no weekly program is set.

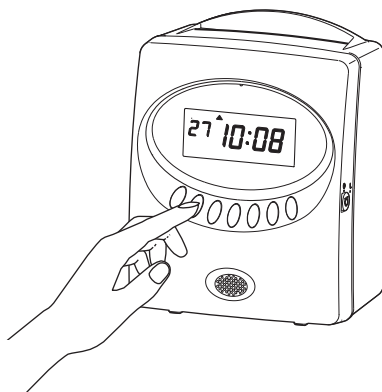

When you want to shift print column, push the desired control button and the above lamp flashes.



If automatic column shift is desired, refer to "Setting the Weekly Program" in "5. SETTINGS".

Only for V/VN Card Users (QR-6560)

Column will automatically shift by distinguishing each card with barcode. (Up to 100 cards can be used for one period.)

Printing OUT time with a special mark for "OVERNIGHT"

To print OUT time with a special mark "◇", first push the OVERNIGHT button and insert a time card.

Note OUT time with "◇" mark is printed in the previous day line.

1 Push the OVERNIGHT button.



2 OVERNIGHT and the 6th column buttons flash.

Point While OVERNIGHT button is flashing, other column can be also selected by pushing the control button.

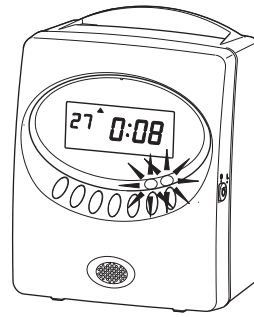

3 Insert a time card.

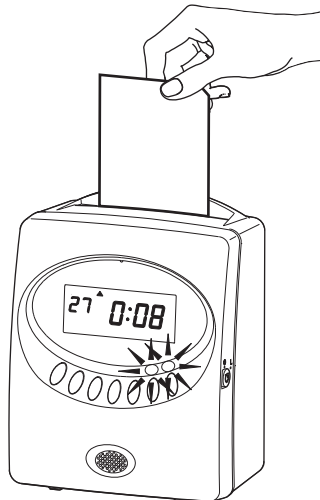

4 OUT time with a special mark "◇" is printed in the previous day column.

An "Overnight" mark is added to the OUT time.

28:56					29:08◇

Print Example

Note If you set Line Format as "5: DD AM/PM" or "6: D.O.W. AM/PM", the special mark is changed to "◆" in the afternoon.



Refer to "Selecting the Print Format" in "5. SETTINGS".

5. SETTINGS

Preparation for Settings

! Make sure the power is on before making setting.

1 Put your fingers in the depressions at the lower side of the cover, and pull it toward you.

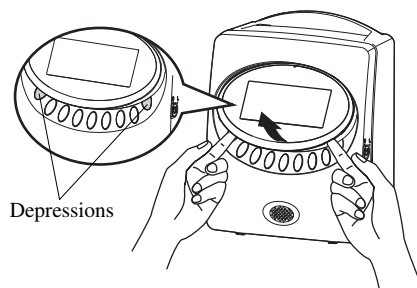

2 While pushing, turn the key to "O" position. At that moment, display will be as shown in the following figure. Then, you can go into the setting mode.

Refer to the following pages for details of each setting.

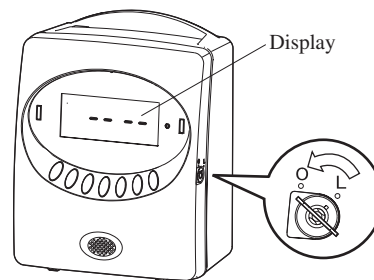

3 After the setting has been completed, push the **SETTING END** button to get out of the setting mode. Turn the key to "L" position. Make sure "date" and "time" are indicated on the display and colon is flashing.

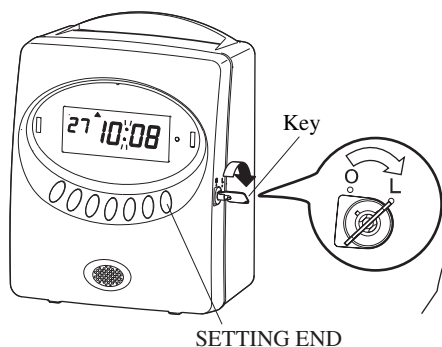

4 Replace the cover. At that time, make sure to fit the tabs at the both side of the cover into the holes on the unit.

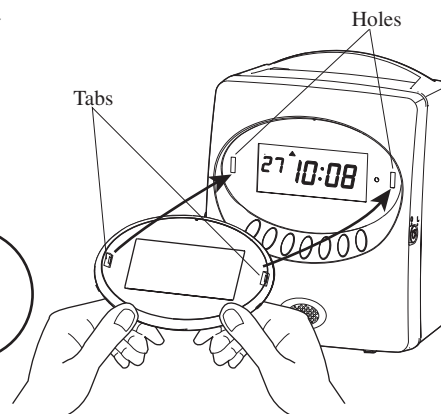

Overview of Control Buttons

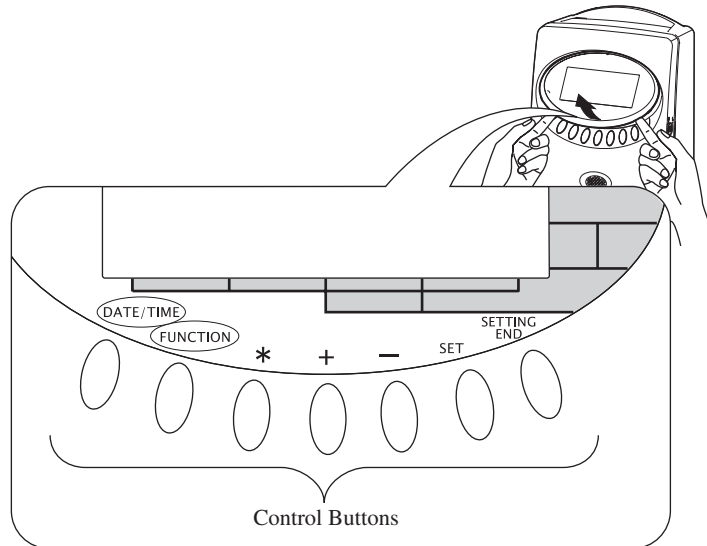

DATE/TIME button

Use the **DATE/TIME** button when you want to change the date and/or time. (Make sure to push it for 1 second before going to setting mode.)

FUNCTION button

Use the **FUNCTION** button when you want to change the pay period, print format, and so on. (Make sure to push it for 1 second before going to setting mode.)

+ or - button

When you push the **+** or **-** button, you can change the set value.

SET button

You can set the value selected on the display by pushing the **SET** button.

SETTING END button

Push this button when you get out of the setting mode.

Selecting the Hour Display Format

You can select desired hour display format from following 2 options.

Order options
1. AM / PM
2. 24 Hour

The clock default is "2: 24 Hour".

! Before you start setting, make sure to see "Preparation for Setting".

Example Change the format to "1: AM / PM".

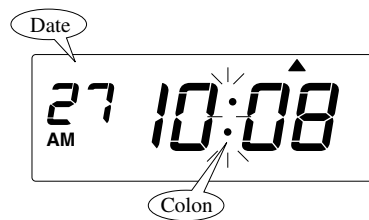
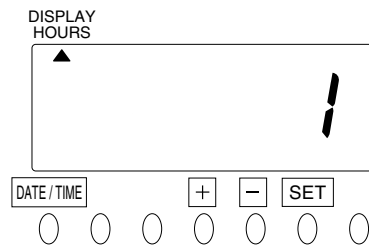
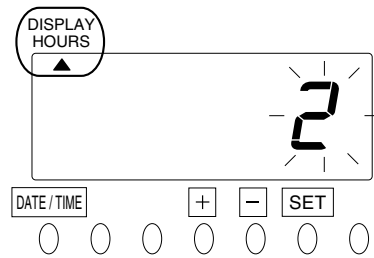

1 Push the **DATE/TIME** button for 1 second and position the "▲" under the "DISPLAY HOURS" mark.

2 In case of the example, push the **+** or **-** button to set at "1" and then push the **SET** button. At that moment, display will stop flashing and the setting is now completed.

3 Push the **SETTING END** button to get out of the setting mode. Turn the key to "L" position. Make sure "date" and "time" are indicated on the display and colon is flashing. Then replace the cover.

Setting the Time



Before you start setting, make sure to see "Preparation for Setting".

Example Change the time from 10:08 to 10:09.

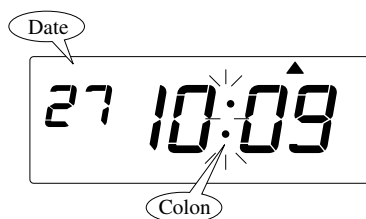
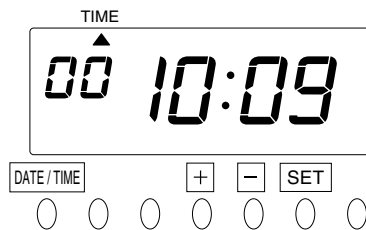
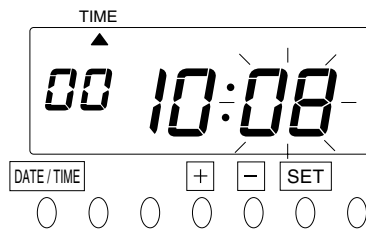
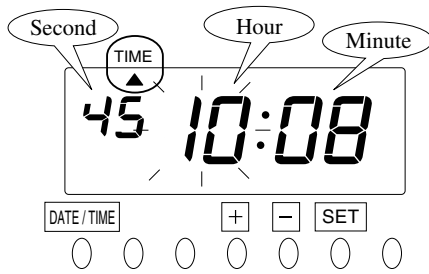

- 1 Push the **DATE/TIME** button for 1 second and position the "▲" under the "TIME" mark.

"▲" mark can be moved by **DATE/TIME** button.

A flashing number can be changed.

- 2 **Change the "Hour"**.

In case of the example, push the **SET** button because the hour is not to be changed. At that moment, the flashing will change from "Hour" to "Minute".

- 3 **Change the "Minute"**.

Push the **+** or **-** button to set "Minute" at "09" and then push the **SET** button.

- 4 Push the **SETTING END** button to get out of the setting mode. Turn the key to "L" position. Make sure "date" and "time" are indicated on the display and "colon" is flashing. Then replace the cover.

Setting the Date



Before you start setting, make sure to see "Preparation for Setting".

Example Change the date from Oct. 26, 2006 to Oct. 27, 2006.

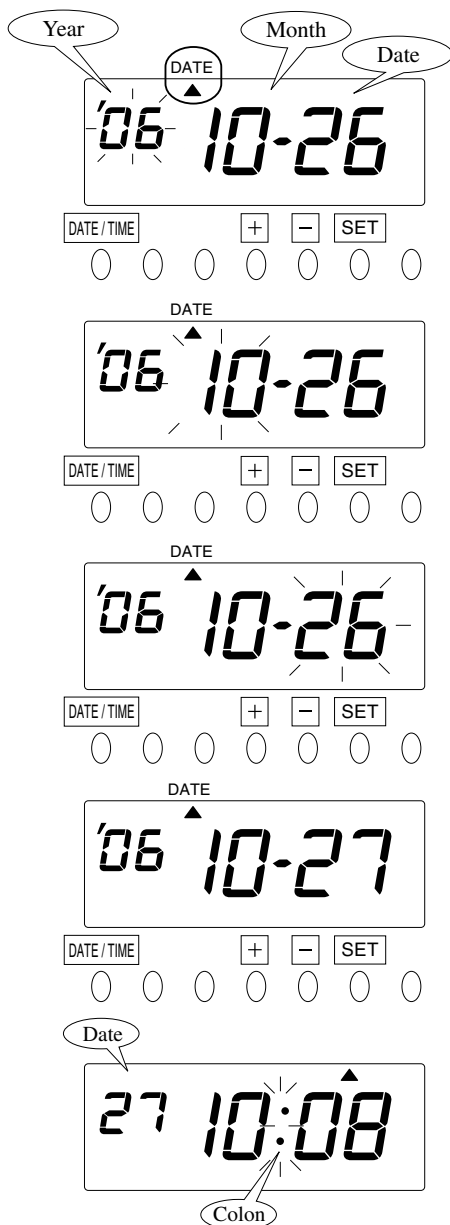

- 1 Push the **DATE/TIME** button for 1 second and position the "▲" under the "DATE" mark.

"▲" mark can be moved by **DATE/TIME** button.

A flashing number can be changed.

- 2 **Change the "Year".**

In case of the example, push the **SET** button because the year 2006 is not to be changed. At that moment, the flashing will change from "Year" to "Month".

- 3 **Change the "Month".**

In case of the example, push the **SET** button because the month of October is not to be changed. At that moment, the flashing will change from "Month" to "Date".

- 4 **Change the "Date".**

Push the **+** or **-** button to set "Date" at "26" and then push the **SET** button. At that moment, the display will stop flashing, and the setting is now completed.

- 5 Push the **SETTING END** button to get out of the setting mode.

Turn the key to "L" position. Make sure "date" and "time" are indicated on the display and "colon" is flashing. Then replace the cover.

Selecting the Card Type

The card type can be selected from the following six options.

Order Options	Card Type	Blank Line
1. V/VN Card*1	Monthly, both sides / Weekly, one side / Bi-weekly, one side	--
2. S Card	Monthly, both sides	--
3. Weekly Card	Weekly, one side	--
4. Bi-weekly Card	Bi-weekly, one side	--
5. Other A Card*2	Monthly, both sides	1 to 32
6. Other B Card*3	Monthly, both sides	1 to 32

The clock default is "2: S Card".

*1. V/VN card is available only with QR-6560.

*2. Automatic differentiation of the front and back.

*3. Without automatic differentiation of the front and back.

The clock default is "16"



Please refer to "13. TIME CARD SPECIFICATIONS".



To make sure pay period ending date ...
Refer to "Setting Pay Period Ending Date/Day".

Only for Other A Card / Other B Card Users

Front side	Back side
<p>16 lines</p>	<p>Blank Line</p> <p>15 lines</p>

"Blank Line" setting is available if you select "5: Other A Card" or "6: Other B Card".

Blank Line is originally set at "16" (the last line on the front side). If you use a time card with a different line format, you can change the printing line by setting blank line.

Example The first line is blank on the back (blank line: 17).

Only for V/VN Card Users (QR-6560)

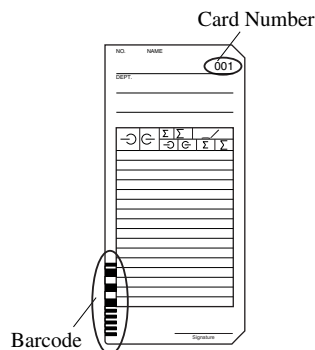

When you select "1: V/VN Card", the clock will remember the last imprint and automatically switch the "IN" and "OUT" columns by distinguishing each card with barcode. (Up to 100 cards can be used for one period.)

Note You can not print in the 1st column by control button after printing in the 2nd column.



You can select the desired pay period (Monthly, Weekly or Bi-weekly). Refer to "Setting Pay Period Ending Date/Day".



Before you start setting, make sure to see "Preparation for Setting".

Example Change the Card Type to "6: Other A Card" and the Blank Line to "1st line".

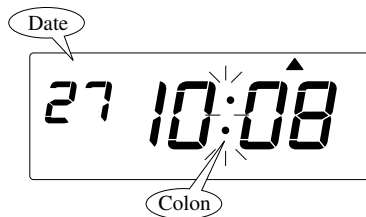
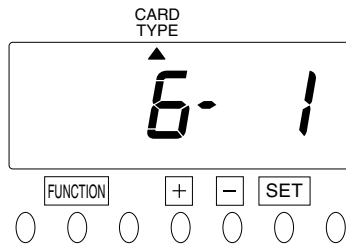
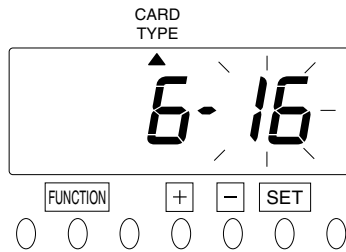
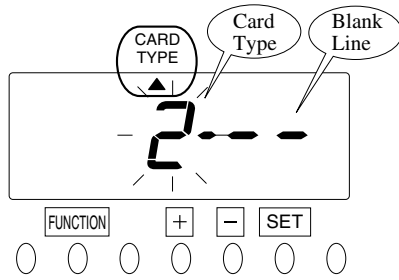

- 1 Push the **FUNCTION** button for 1 second and position the "▲" under the "CARD TYPE" mark.

A flashing number can be changed.

- 2 **Change the "Card Type".**

In case of the example, push the **+** or **-** button to set "Card Type" at "6" and then push the **SET** button. At that moment, the flashing will change from "Card Type" to "Blank Line".

If you select the Card Type except "5" or "6", go on step 4.

- 3 **Change the "Blank Line".**

In case of the example, push the **+** or **-** button to set at "1" and then push the **SET** button. At that moment, the display will stop flashing, and the setting is now completed.

- 4 Push the **SETTING END** button to get out of the setting mode. Turn the key to "L" position. Make sure "date" and "time" are indicated on the display and "colon" is flashing. Then replace the cover.

Setting Pay Period Ending Date/Day

Monthly/Weekly/Bi-weekly

This function is available if you select "monthly card" in the card type setting.

The clock default is "31".



Before you start setting, make sure to see "Preparation for Setting".

Example Change the Pay Period Ending Date to the 20th.

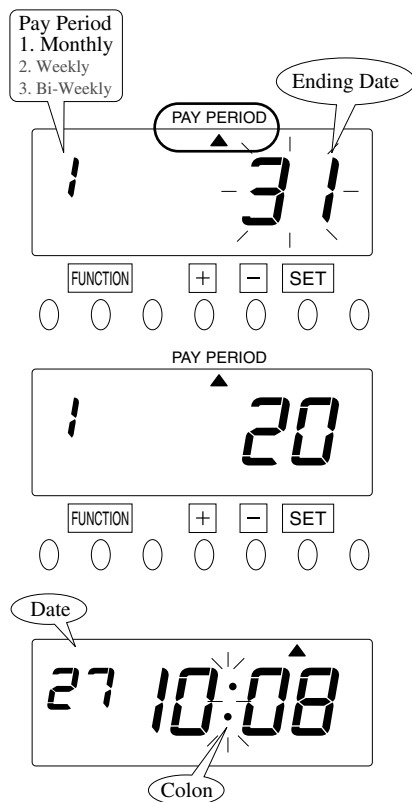

- 1 Push the **FUNCTION** button for 1 second and position the "▲" under the "PAY PERIOD" mark.

"▲" mark can be moved by **FUNCTION** button.

A flashing number can be changed.

*For V/VN Card Users, refer to below "How to set the Pay Period".

- 2 In case of the example, push the **+** or **-** button to set "Ending Date" at "20", and then push the **SET** button. At that moment, the display will stop flashing and the setting is now completed.

- 3 Push the **SETTING END** button to get out of the setting mode. Turn the key to "L" position. Make sure "date" and "time" are indicated on the display and "colon" is flashing. Then replace the cover.

Only for V/VN Card Users (QR-6560)

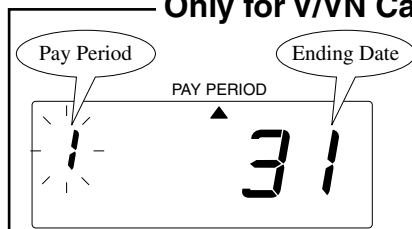

How to set the pay period

You can select "Pay Period" by the **+** or **-** buttons, and push the **SET** button.

At that moment, the flashing will change to "Ending Date (/Day)", and then go on Step 2.

Monthly/Weekly/Bi-weekly

This function is available if you select "weekly card" in the card type setting.

You can set the desired day, which comes within a week from today. The pay period ending date is the number of days from the date you are setting the clock.

The clock default is "0 (today)".



Before you start setting, make sure to see "Preparation for Setting".

Example

Today	Ending day
September 22	September 24
Friday	Sunday

0 1 2

Assume that today is Friday, September 22, 2006 and the ending day is Sunday. As illustrated in the left figure, ending day (Sunday) is two days after.

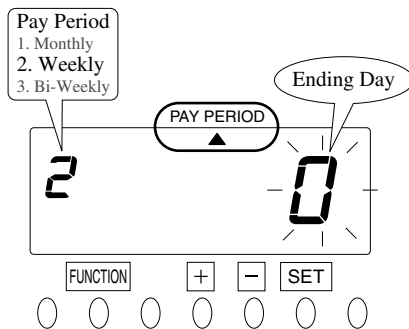

- 1 Push the **FUNCTION** button for 1 second, and position the "▲" under the "PAY PERIOD" mark.

"▲" mark can be moved by **FUNCTION** button.

A flashing number can be changed.

*For V/VN Card Users, refer to "How to set the Pay Period" in "Monthly" setting (p.18).

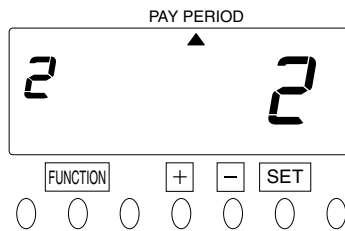

- 2 Push the **+** or **-** button to set "Ending Day" at "2" and then push the **SET** button. At that moment, the display will stop flashing and the setting is now completed.

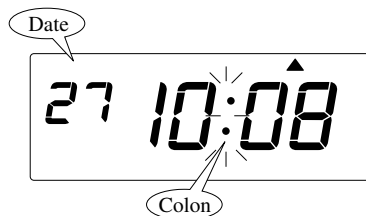

- 3 Push the **SETTING END** button to get out of the setting mode. Turn the key to "L" position. Make sure "date" and "time" are indicated on the display and "colon" is flashing. Then replace the cover.

Monthly/Weekly/Bi-weekly

This function is available if you select "bi-weekly card" in the card type setting.

You can set the desired day, which comes within two weeks from today. The pay period ending date is the number of days from the date you are setting the clock.

The clock default is "0 (today)".



Before you start setting, make sure to see "Preparation for Setting".

Example

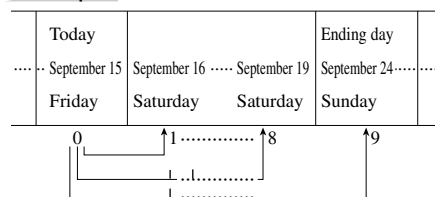

Assume that today is Friday, September 15, 2006 and the ending day is Sunday the week after next. As illustrated in the left figure, ending day (Sunday) is nine days after.

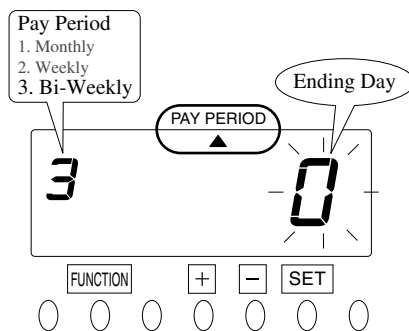

- 1 Push the **FUNCTION** button for 1 second, and position the "▲" under the "PAY PERIOD" mark.

"▲" mark can be moved by **FUNCTION** button.

A flashing number can be changed.

*For V/VN Card Users, refer to "How to set the Pay Period" in "Monthly" setting (p.18).

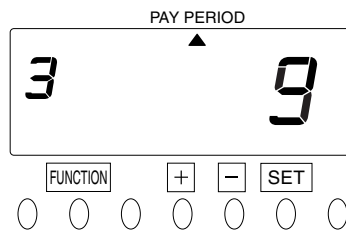

- 2 Push the **+** or **-** button to set "Ending Day" at "9" and then push the **SET** button. At that moment, the display will stop flashing and the setting is now completed.

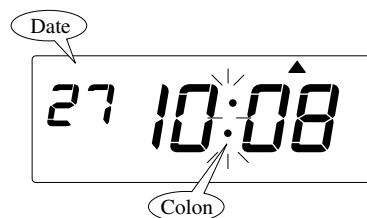

- 3 Push the **SETTING END** button to get out of the setting mode. Turn the key to "L" position. Make sure "date" and "time" are indicated on the display and "colon" is flashing. Then replace the cover.

Setting the Day Advance Time

The Day Advance Time refers to the time when printing shifts to the next line on a time card for the next day. This function enables the punch out time record to print on the same line of the previous working day even if leaving time is after midnight. The clock default is "5:00".



Before you start setting, make sure to see "Preparation for Setting".

Example Change the Day Advance Time from 5:00 to 7:00.

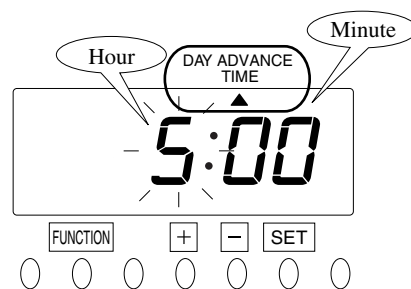

- 1 Push the **FUNCTION** button for 1 second, and position the "▲" under the "DAY ADVANCE TIME" mark.

"▲" mark can be moved by **FUNCTION** button.

A flashing number can be changed.

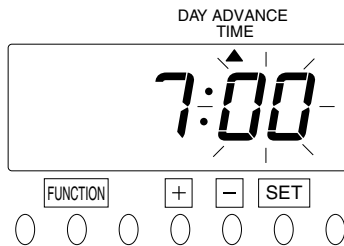

- 2 **Change the "Hour"**.

In case of the example, push the **+** or **-** button to set the hour at "7" and then push the **SET** button. At that moment, the flashing will change from "Hour" to "Minute".

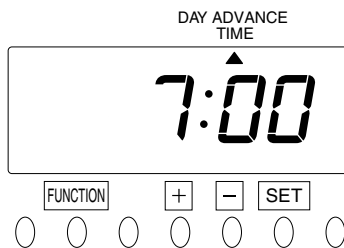

- 3 **Change the "Minute"**.

In case of the example, push the **SET** button because the minute is not to be changed. At that moment, the display will stop flashing and the setting is now completed.

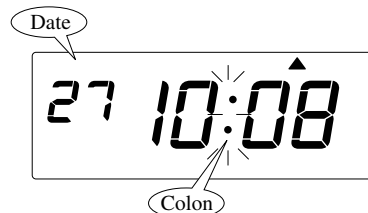

- 4 Push the **SETTING END** button to get out of the setting mode.

Turn the key to "L" position. Make sure "date" and "time" are indicated on the display and "colon" is flashing. Then replace the cover.

Selecting the Print Format

You can select desired Line Format (6 types) and Minute Type (2 types).

Line Format

Order Options	Line Format	Print Example: Monday, 21, 3:30 p.m.
1. DD 24HR	date, 24hour, minute	21 15 : 30
2. D.O.W. 24HR	day of the week, 24hour, minute	Mo 15 : 30
3. 24HR Large Font	24hour, minute	15 : 30
4. AM/PM	12hour, minute	Pm 3 : 30
5. DD AM/PM	date, 12hour, minute	21 3 : 30 P
6. D.O.W AM/PM	day of the week, 12hour, minute	Mo 3 : 30 P

The clock default is "1: DD 24HR".

Minute Type

Order options	Print Example: 8:34
1. 1/60	8: 34
2. 1/100	8. 57

The clock default is "1: 1/60".



Before you start setting, make sure to see "Preparation for Setting".

Example Change the Line Format to "5: DD AM/PM" and the Minute Type to "2: 1/100" min.

Print Example 21 3. 50 P (Monday, 21, 15:30)

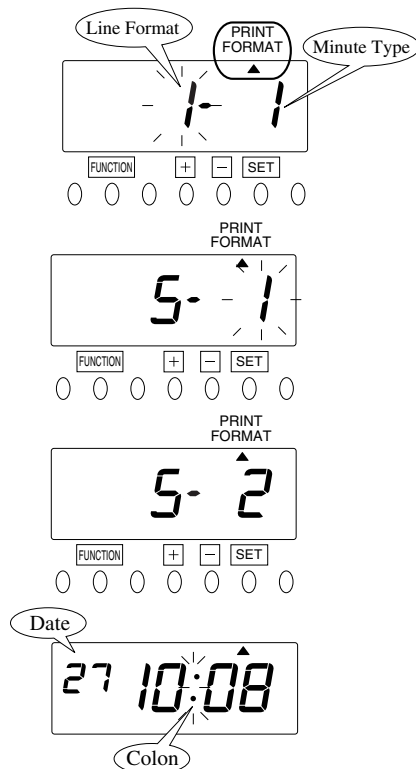

- 1 Push the **FUNCTION** button for 1 second and position the "▲" under the "PRINT FORMAT" mark.

"▲" mark can be moved by **FUNCTION** button.

A flashing number can be changed.

- 2 **Select the "Line Format".**

In case of the example, push the **+** or **-** button to set "Line Format" at "5" and then push the **SET** button. At that moment, the flashing will change to "Minute Type".

- 3 **Select the "Minute Type".**

In case of the example, push the **+** or **-** button to set "Minute Type" at "2" and then push the **SET** button. At that moment, the display will stop flashing and the setting is now completed.

- 4 Push the **SETTING END** button to get out of the setting mode.

Turn the key to "L" position. Make sure "date" and "time" are indicated on the display and "colon" is flashing. Then replace the cover.

Selecting the Language

You can select desired languages from following 6 options.

Order options	Print example: Thursday 3:30 p.m.
1. English	TH 15 : 30
2. Spanish	JU 15 : 30
3. German	DO 15 : 30
4. French	JE 15 : 30
5. Italian	GI 15 : 30
6. Portuguese	QI 15 : 30

The clock default is "1: English".



Before you start setting, make sure to see "Preparation for Setting".

Example Change the Language to "4: French".

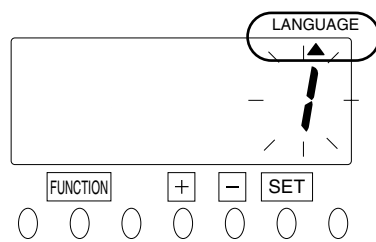

- 1 Push the **FUNCTION** button for 1 second, and position the "▲" under the "LANGUAGE" mark.

"▲" mark can be moved by **FUNCTION** button.

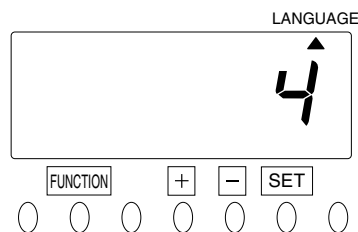

- 2 In case of the example, push the **+** or **-** button to set at "4" and then push the **SET** button. At that moment, the display will stop flashing and the setting is now completed.

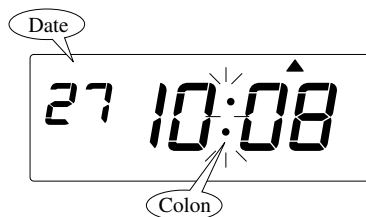

- 3 Push the **SETTING END** button to get out of the setting mode. Turn the key to "L" position. Make sure "date" and "time" are indicated on the display and "colon" is flashing. Then replace the cover.

Setting the Daylight Saving Time

Daylight saving time function

◆ D.S.T. execution time

At 2:00 a.m. on the first day of summer time, the clock automatically gains one hour to show 3:00 a.m. When 3:00 a.m. comes on the last day of the summer time period, it loses one hour and returns to 2:00 a.m.

Note "*" mark is printed in the overlapped hour.

◆ 2 Setting D.S.T.

Example

Start date Sunday, March 26, 2006

End date Sunday, October 29, 2006

If set as the above, the unit remembers the start date as the last Sunday of March and the end date as the last Sunday of October. Once set, the unit automatically updates the settings every year thereafter. NO further manual settings is necessary.

The setting for daylight saving time will be described using the following example.

Example

Today (present day)	Wednesday, January 25, 2006	
Starting date of daylight saving time	Sunday, March 26, 2006	The last Sunday of March
Ending date of daylight saving time	Sunday, October 29, 2006	The last Sunday of October

Note This function will be available only when you set both Starting and Ending date.

Setting the Starting Date of Daylight Saving Time



Before you start setting, make sure to see "Preparation for Setting".

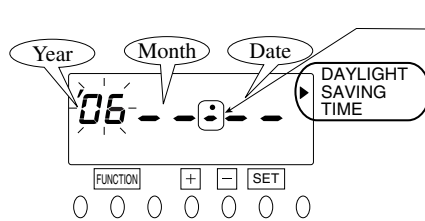

"▲" mark means "starting date".

- 1 Push the **FUNCTION** button for 1 second, and position the "▲" next to the "DAYLIGHT SAVING TIME" mark.

"▲" mark can be moved by **FUNCTION** button.

A flashing number can be changed.

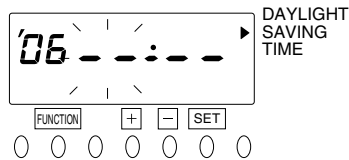

- 2 **Change the "Year".**

In case of the example, push the **SET** button because the hour is not to be changed. At that moment, the flashing will change from "Year" to "Month".

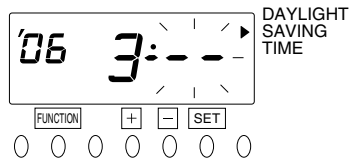

- 3 **Change the "Month".**

Push the **+** or **-** button to set at "3" and push the **SET** button. At that moment, the flashing will change from "Month" to "Date".



- 4 **Change the "Date".**

Push the **+** or **-** button to set at "26" and then push the **SET** button. At that moment, the display will stop flashing and the "▲" is displayed under "SU". Now the starting date of D.S.T. setting has been completed.

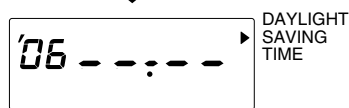

Go on "Setting The Ending Date of Daylight Saving Time".

Setting the Ending Date of Daylight Saving Time

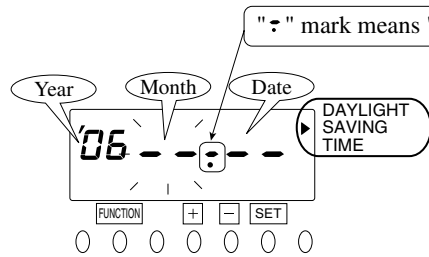

5 Change the "Year".

Next, push the **SET** button. At that moment, the flashing will change "Year" to "Month".

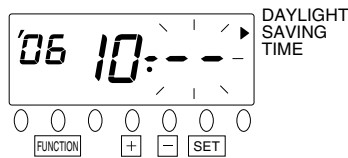

6 Change the "Month".

Push the **+** or **-** button to set at "10" and then push the **SET** button. At that moment, the flashing will change from "Month" to "Date".



7 Change the "Date".

Push the **+** or **-** button to set at "29" and then push the **SET** button. At that moment, the display will stop flashing and the "▲" mark is displayed under "SU". Now the ending date of D.S.T. setting has been completed.

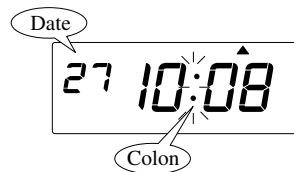

8 Push the **SETTING END** button to get out of the setting mode.

Turn the key to "L" position. Make sure "date" and "time" are indicated on the display and "colon" is flashing. Then replace the cover.

Deleting the Daylight Saving Time Settings

! Before you start setting, make sure to see "Preparation for Setting".

Point To delete and cancel the daylight saving time settings, change the display of "Month" of the starting date to "--".

Example To change March 26, 2006 of "starting date" and delete daylight saving time settings.

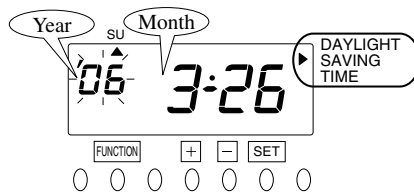

- 1 Push the **FUNCTION** button for 1 second, and position the "▲" next to the "DAYLIGHT SAVING TIME" mark.

"▲" mark can be moved by **FUNCTION** button.

A flashing number can be changed.

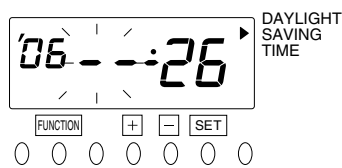

- 2 **Delete the "Month"**.

Push the **SET** button and then the flashing will change from "Year" to "Month". Next, push the **+** or **-** button to set at "--".

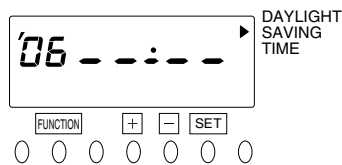

- 3 **Cancel the "D.S.T. Settings"**.

Push the **SET** button. This cancels the daylight saving time settings.

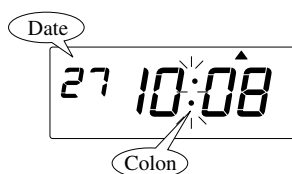

- 4 Push the **SETTING END** button to get out of the setting mode. Turn the key to "L" position. Make sure "date" and "time" are indicated on the display and "colon" is flashing. Then replace the cover.

Setting the Weekly Program

QR-6550

Weekly Programs enable the clock to memorize the following functions for specified time periods. Times are always printed in 1st Column for the time period unless any program for print column is set.

Function No.	Function
1.	Automatic IN/OUT printing column shift
2.	Special mark "▲" for irregular recognition

Note Up to 48 programs can be set.

== The time table program is explained using the following example. ==

Example

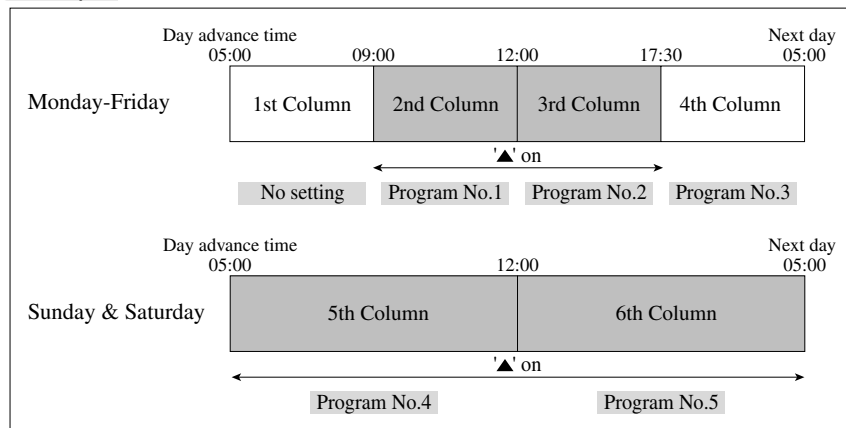

Time table

Program No.	Day of the Week	Time	Print Column	Print Irregular Mark
1	Mon.-Fri.	9:00	2	On
2	Mon.-Fri.	12:00	3	On
3	Mon.-Fri.	17:30	4	Off
4	Sun.& Sat.	5:00	5	On
5	Sun.& Sat.	12:00	6	On

Note One programmed day begins at the day advance time.
Refer to "Setting Day Advance Time" in the section of this manual.

QR-6550

Print Example

The following is the print example based on the case of the previous page.

Date D.O.W.
 21st Thu.
 22nd Fri.
 23rd Sat.
 24th Sun
 25th Mon.
 ⋮
 29th Fri.

ㄹ 8:46			ㄹ 17:48		
ㄹ 8:50	ㄹ 11:53▲	ㄹ 14:10▲	ㄹ 19:22		
				ㄹ 9:22 ▲	ㄹ 17:50▲
	ㄹ 9:06▲		ㄹ 17:51		
ㄹ 8:46A	ㄹ 10:29▲	ㄹ 2:30 ▼	ㄹ 6:03P		

Note If you set "Line Format" as "5: DD AM/PM" or "6: D.O.W. AM/PM", the irregular mark is changed to "▼" in the afternoon.



For setting "Line Format", please refer to "Selecting the Print Format".

! Before you start setting, make sure to see "Preparation for Setting".

Point To complete the "Weekly Program" settings, follow the procedure below.

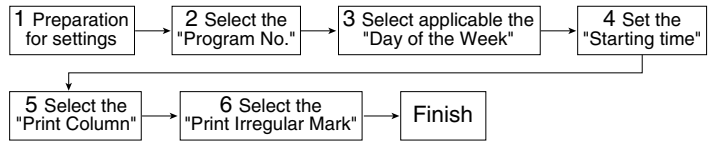

Setting Program No.1

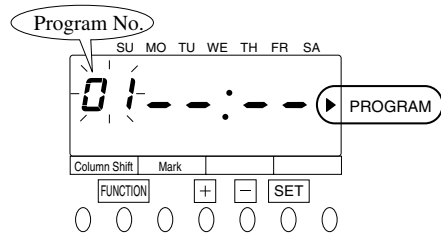

1 Preparation for settings.
 Push the [FUNCTION] button for 1 second, and position the "▲" next to the "PROGRAM" mark.
 "▲" mark can be moved by [FUNCTION] button.

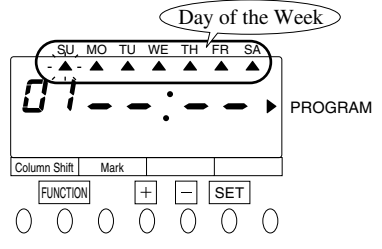

2 Select the "Program No."
 In case of the example, push the [SET] button because the "Program No." is not to be changed. At that moment, the display will be as shown in the figure at left and you can set the "Day of the week".

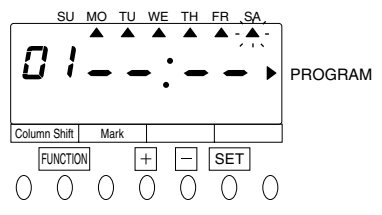

3 Select applicable the "Day of the Week"
 In case of the example, push the [-] button not to select weekly program on Sunday. Then the flashing will move to "▲" under "MO", and push the [+] button to select on Monday. In the same manner, push the [+] button for Tuesday to Friday, and the [-] button for Saturday.

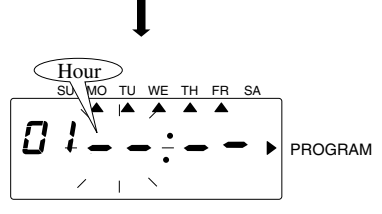

After completed, the flashing will change to "Hour".

QR-6550

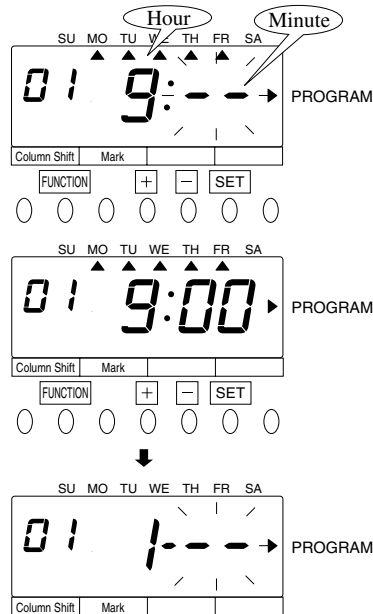

4 Set the "Starting Time".

In case of the example, push the \oplus or \ominus button to set "Hour" at "9" and then push the SET button.

At that moment, flashing of the display will change from "Hour" to "Minute".

Push the \oplus or \ominus button to set "Minute" at "00" and then push the SET button.

When the display will be as shown in the figure at left, go on the next setting "Print Column".

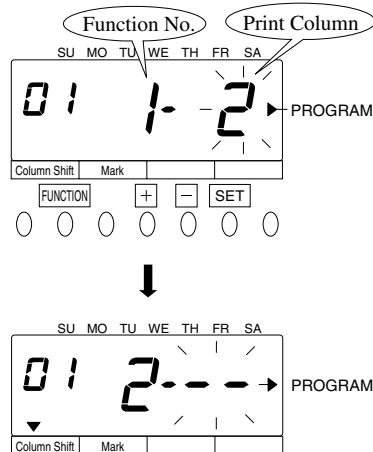

5 Select the "Print Column".

Order options					
--	Not selected*				
1.	1st Column	4.	4th Column		
2.	2nd Column	5.	5th Column		
3.	3rd Column	6.	6th Column		

*Current status remains.

In case of the example, push the \oplus or \ominus button to set at "2" and then push the SET button.

When the display will be as shown in the figure at left, go on the next setting "Print Irregular Mark".

QR-6550

6 Select the "Print Irregular Mark".

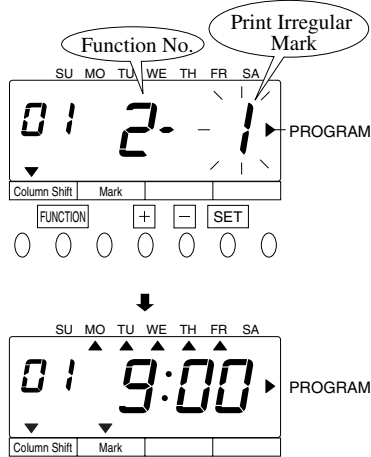

Order options	
--	Not selected*
1.	Mark on
2.	Mark off

*Current status remains.

In case of the example, push the **+** or **-** button to set at "1" and push the **SET** button.

At that moment, the display will be as shown in the figure at left and the setting of "Program No.1" has been completed.

Then you can proceed "Setting the Program No.2".

Setting the Program No.2-5

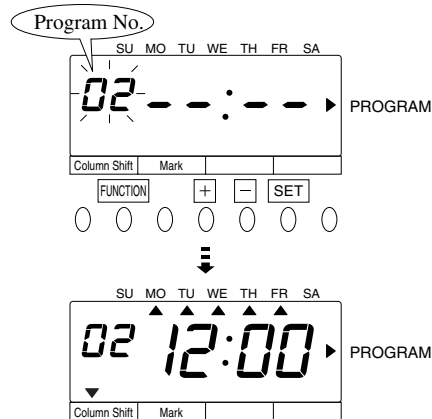

Push the **+** button and the "Program No." will start flashing.

Push the **+** button once again to set the Program No. at "2".

Make settings for Program No.2-5 in the same manner as for program No.1.

End Setting

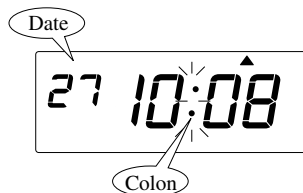

When all the programs are set, push the **SETTING END** button to get out of the setting mode.

Turn the key to "L" position. Make sure "date" and "time" are indicated on the display and colon is flashing. Then replace the cover.

Setting the Weekly Program

QR-6560

Weekly Programs enable the clock to memorize the following functions for specified time periods. Times are always printed in 1st Column for the time period unless any program for print column is set.

Function No	Function
1.	Automatic IN/OUT printing column shift
2.	Automatic selection of print color (Black or Red)
3.	Output signal for external signal
4.	Playing melody*

Note Up to 48 programs can be set.

*You can preview each melody when setting it.

== The time table program is explained using the following example. ==

Example

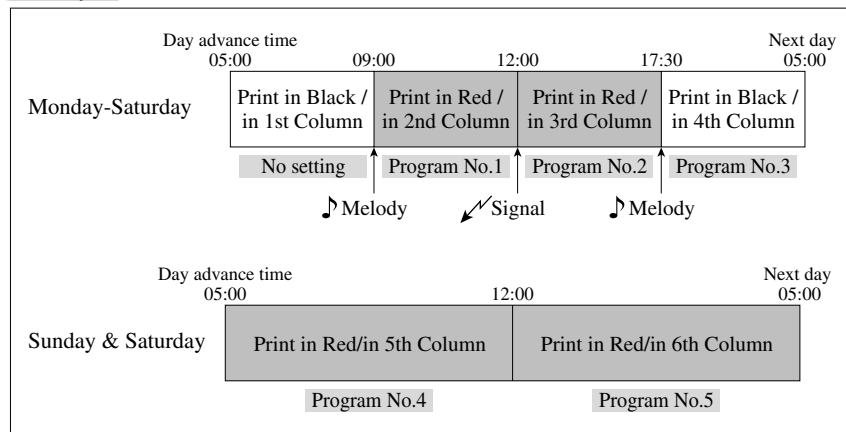

Time table

Program No.	Day of the Week	Time	Print Column	Print Color	External Time Signal	Melody
1	Mon.-Fri.	9:00	2	Red		1
2	Mon.-Fri.	12:00	3	Red	For 10 seconds	
3	Mon.-Fri.	17:30	4	Black		1
4	Sun.& Sat.	5:00	5	Red		
5	Sun.& Sat.	12:00	6	Red		

Note One programmed day begins at the day advance time.

Refer to "Setting Day Advance Time" .

! Before you start setting, make sure to see "Preparation for Setting".

Point To complete the "Weekly Program" settings, follow the procedure below.

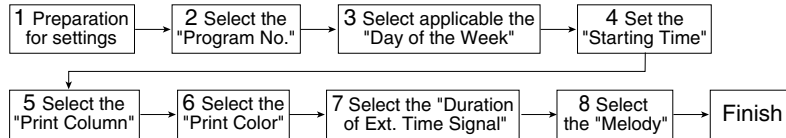

Setting Program No.1

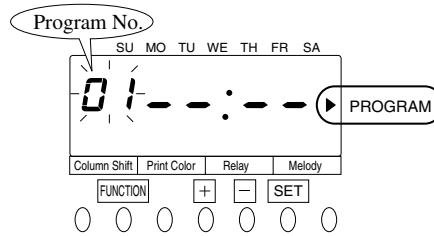

1 Preparation for settings.

Push the **FUNCTION** button for 1 second, and position the "▲" next to the "PROGRAM" mark.

"▲" mark can be moved by **FUNCTION** button.

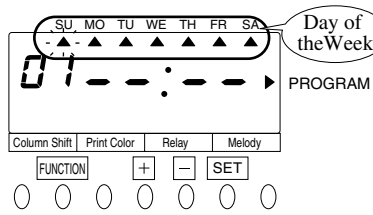

2 Select the "Program No.".

In case of the example, push the **SET** button because the "Program No." is not to be changed. At that moment, the display will be as shown in the figure at left and you can set the "Day of the Week".

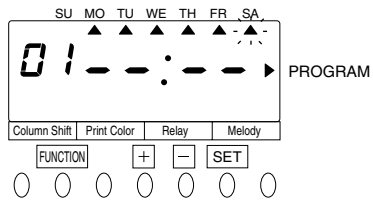

3 Select applicable the "Day of the Week".

In case of the example, push the **-** button not to select weekly program on Sunday. Then the flashing will move to "▲" under "MO", and push the **+** button to select on Monday. In the same manner, push the **+** button for Tuesday to Friday, and the **-** button for Saturday.

After completed, the flashing will change to "Hour".

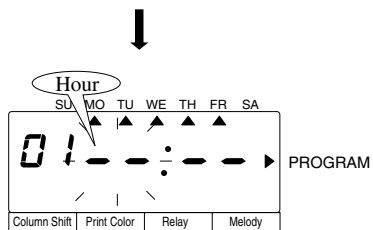

QR-6560

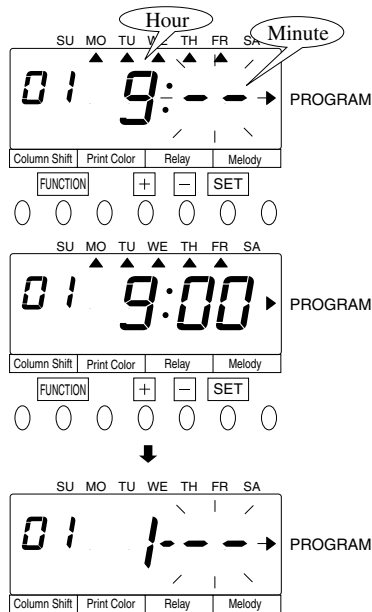

4 Set the "Starting Time".

In case of the example, push the \oplus or \ominus button to set at "9" and then push the **SET** button.

At that moment, flashing of the display will change from "Hour" to "Minute".

Push the \oplus or \ominus button to set "Minute" at "00" and then push the **SET** button.

When the display will be as shown in the figure at left, go on the next setting "Print Column".

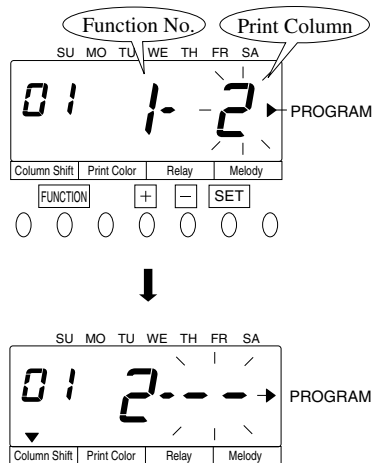

5 Select the "Print Column".

Order options			
--	Not selected*		
1.	1st Column	4.	4th Column
2.	2nd Column	5.	5th Column
3.	3rd Column	6.	6th Column

*Current status remains.

In case of the example, push the \oplus or \ominus button to set at "2" and then push the **SET** button.

When the display will be as shown in the figure at left, go on the next setting "Print Color".

QR-6560

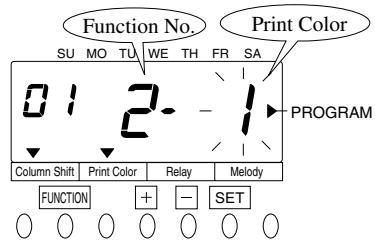

6 Select the "Print Color".

Order options	
--	Not selected*
1.	Red
2.	Black

*Current status remains.

In case of the example, push the **+** or **-** button to set at "1" and push the **SET** button.

When the display will be as shown in the figure at left, go on the next setting "Duration of Ext. Time Signal".

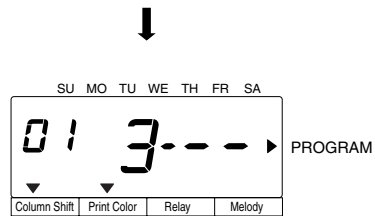

7 Select the "Duration of Ext. Time Signal".

Order options		Duration hours
--	Disabled	
1.	Duration 1	5 sec.
2.	Duration 2	10 sec.
3.	Duration 3	20 sec.

Above-mentioned "Duration Hours" are the default values. If you'd like to change duration to your desired hours, please refer to "Setting the Duration of External Time Signal".

In case of the example, since this setting is not applicable, push the **SET** button with "--" indicated on the display.

When the display will be as shown in the figure at left, go on the next setting "Melody".

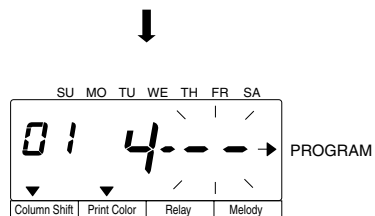
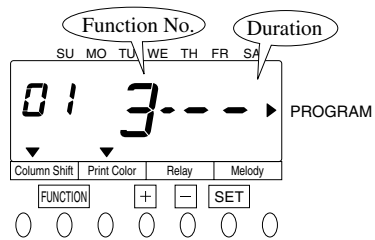

QR-6560

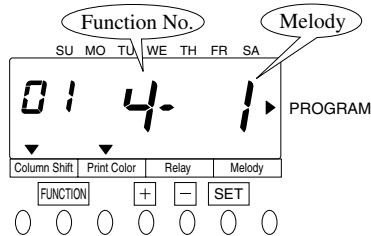

8 Select the "Melody".

Order options				
--	Disabled	3.	Long Long Ago	
1.	Westminster Chime	4.	Home, Sweet Home	
2.	Greensleeves	5.	Danny Boy	



You can select volume of melodies from "Standard" or "High" level. Refer to "Selecting Volume of Melodies".

In case of the example, push the **+** or **-** button to set at "1" and then push the **SET** button.

At that moment, the display will be as shown in the figure at left and the setting of "Program No.1" has been set.

Then you can proceed to "Setting the Program No.2".



Setting the Program No.2-5

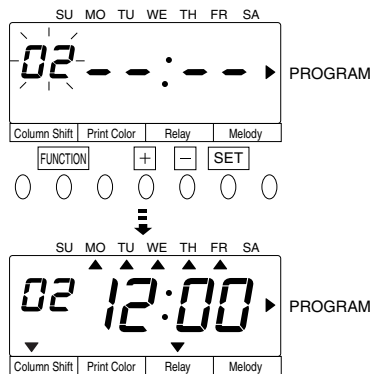

Push the **+** button and the "Program No." will start flashing. Push the **+** button once again to set the "Program No." at "2".

Make settings for Program No.2-5 in the same manner as for program No.1.

End Setting

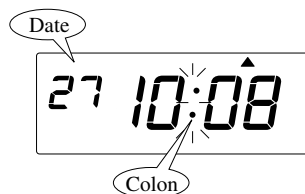

If all the programs have been set then push the **SETTING END** button to get out of the setting mode.

Turn the key to "L" position. Make sure "date" and "time" are indicated on the display and "colon" is flashing. Then replace the cover.

Confirming the Weekly Program

Refer to the Step 1 and Step 2 in the previous setting section, the program No. changes by pushing $\boxed{+}$ button (01→02→03...) and you can confirm each setting.

Note You can confirm each function with "▲" mark on, if it is selected.

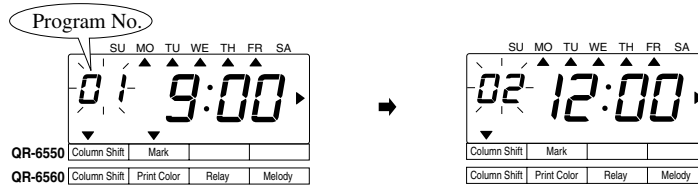

If you want to confirm all detailed settings in one time, printing list of program settings is available.

Refer to "6. PRINTING LIST OF SETTING INFORMATION".

Changing the Weekly Program

Refer to the Step 1 and Step 2 in the previous setting section and select the program No. by pushing $\boxed{+}$ button, which you want to change settings. Once desired program number starts flashing, push the $\boxed{\text{SET}}$ button and change settings in the same manner as you originally set.

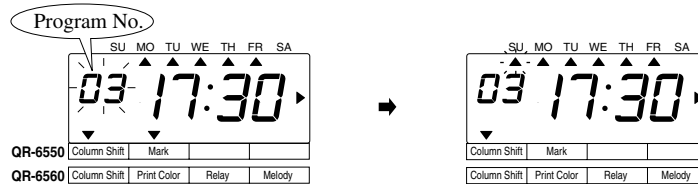

Deleting the Weekly Program

Refer to the Step 1 and Step 2 in the previous setting section and select the program No. by pushing $\boxed{+}$ button, which you want to delete settings. Once the desired program No. starts flashing, push the $\boxed{\text{SET}}$ button and delete the "▲" mark under the selected "day of the week" by pushing the $\boxed{-}$ button. Then, push the $\boxed{\text{SET}}$ button. At that moment, the display will be as shown in the following figure and now program is deleted.

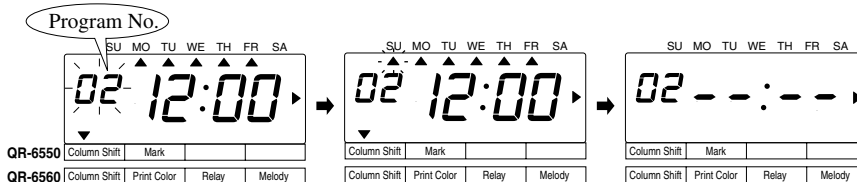

Setting Duration of External Time Signal QR-6560

You can set desired durations up to three patterns.

Duration No.	Duration (default value)
Duration 1	5 sec.
Duration 2	10 sec.
Duration 3	20 sec.

Note Selectable from 1 to 30 seconds.



Before you start setting, make sure to see "Preparation for Setting".

Example Change duration from "10" to "15" in the Duration No.2.

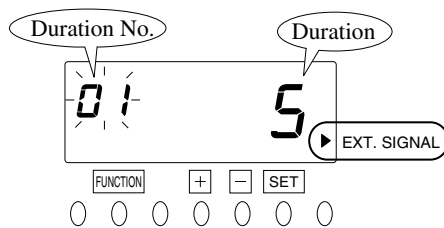

- 1** Push the **FUNCTION** button for 1 second, and position the "▲" next to the "EXT. SIGNAL" mark.

"▲" mark can be moved by **FUNCTION** button.

A flashing number can be changed.

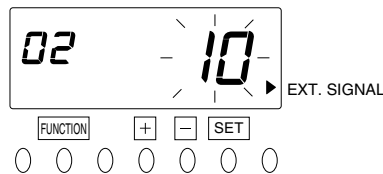

- 2** In case of the example, push the **+** or **-** button to set "Duration No." at "2" and then push the **SET** button. At that moment, the flashing will change to "Duration".

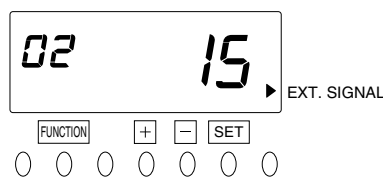

- 3** In case of the example, push the **+** or **-** button to set at "15", and then push the **SET** button. At that moment, the display will stop flashing, and the setting is now completed.

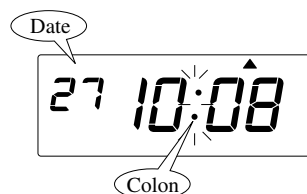

- 4** Push the **SETTING END** button to get out of the setting mode. Turn the key to "L" position. Make sure "date" and "time" are indicated on the display and "colon" is flashing. Then replace the cover.

Selecting Volume of Melodies

QR-6560

You can select volume of melodies from 2 levels.

Order Options
1. Standard
2. High

The clock default is "1: Standard".



Before you start setting, make sure to see "Preparation for Setting".

Example Change the volume level to "2: High".

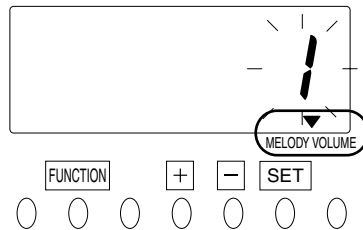

- 1 Push the **FUNCTION** button for 1 second, and position the "▲" over the "MELODY VOLUME" mark.

"▲" mark can be moved by **FUNCTION** button.

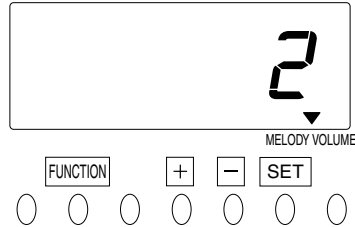

- 2 In case of the example, push the **+** or **-** button to set at "2" and then push the **SET** button. At that moment, the display will stop flashing, and the setting is now completed.

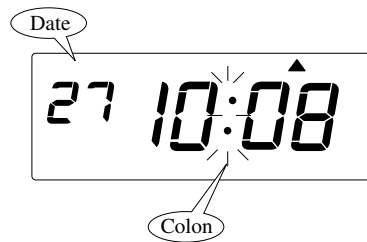

- 3 Push the **SETTING END** button to get out of the setting mode. Turn the key to "L" position. Make sure "date" and "time" are indicated on the display and "colon" is flashing. Then replace the cover.

Setting the Password

Once the password is set, you are requested to enter the current password before changing any setting. If the password you entered does not coincide with the setting, you cannot change the setting values.

You can select any 4-digit number from 0001 to 9998 as your password.

Note Numbers "0000" and "9999" are not valid as password.



All settings must be reset if you forget the password. Refer to "7. RESETTING".



Before you start setting, make sure to see "Preparation for Setting".

Example Set the password "1234".

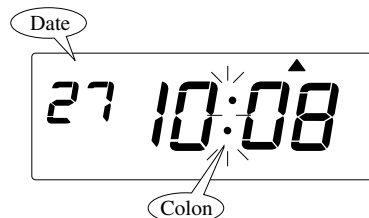
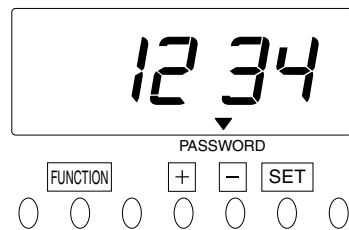
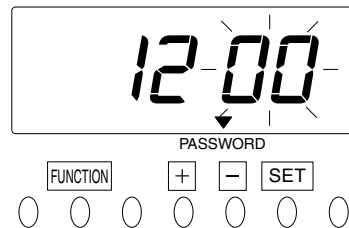
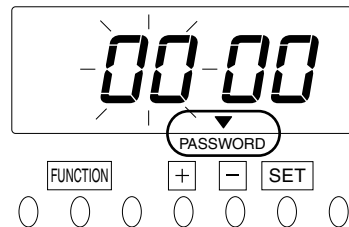

- 1 Push the **FUNCTION** button for 1 second, and position the "▲" over the "PASSWORD" mark.

"▲" mark can be moved by **FUNCTION** button.

A flashing number can be changed.

- 2 **Set the first two digits.**

In case of the example, push the **+** or **-** button to set at "12" and then push the **SET** button. At that moment, the flashing will change to the last two digits.

- 3 **Set the last two digits.**

Next, push the **+** or **-** button to set at "34" and then push the **SET** button. At that moment, the display will stop flashing, and the setting is now completed.

- 4 Push the **SETTING END** button to get out of the setting mode. Turn the key to "L" position. Make sure "date" and "time" are indicated on the display and "colon" is flashing. Then replace the cover.

How to Change Settings When the Password Is Set

Once the password is set, you are requested to enter the current password before changing any setting.



Before you start setting, make sure to see "Preparation for Setting".

Example The current password is "1234" and go into the "FUNCTION" setting mode.

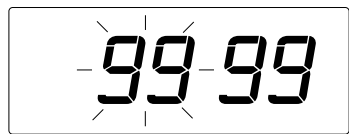

- 1 Push the **FUNCTION** button for 1 second. Then, "9999" will be indicated on the display and the first two digits flash.

A flashing number can be changed.

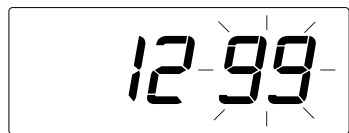

- 2 **Enter the first two digits.**

In case of the example, push the **+** or **-** button to set at "12" and then push the **SET** button. At that moment, the flashing will change to the last two digits.

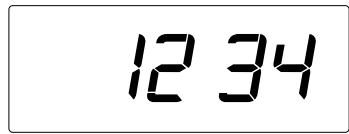

- 3 **Enter the last two digits.**

In case of the example, push the **+** or **-** button to set at "34" and then push the **SET** button. At that moment, the "▲" mark is located under "CARD TYPE".

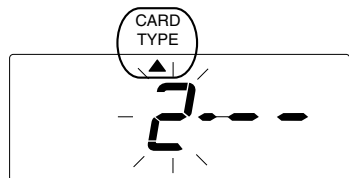

- 4 Select desired setting mode by pushing the **FUNCTION** button. Then make any changes as explained.

DISPLAY HOURS
▲

Note If you want to change any "DATE/TIME" settings, push the **DATE/TIME** button in Step 1 instead. After entering the Password, the display will be as shown in the left figure and then make any changes as explained.

Canceling the Password



Before you start setting, make sure to see "Preparation for Setting".

Point To cancel the Password, the current one must be changed to "0000".

Example The current password is "1234" and cancel it.

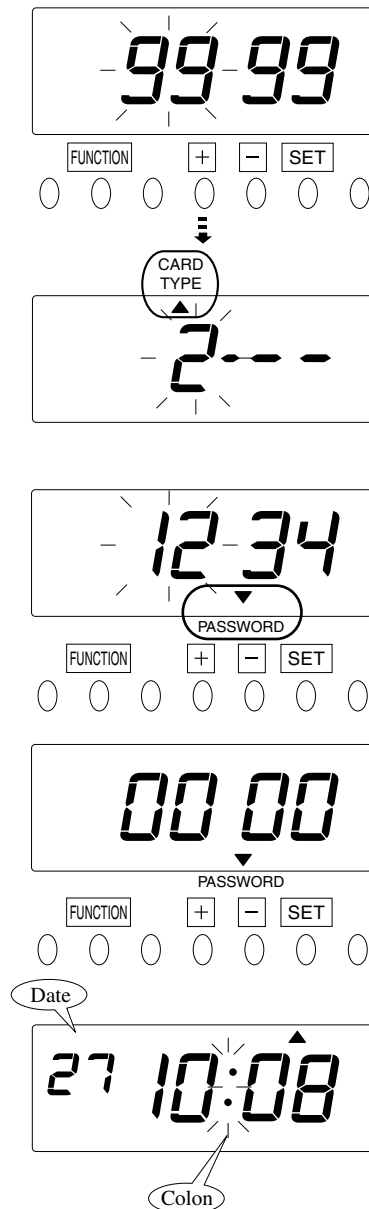

- 1 Push the **FUNCTION** button for 1 second and then enter the Password.



For entering Password, refer to Step 1 to 3 in "How to Change Settings When the Password Is Set" (previous page).

- 2 Position the "▲" over the "PASSWORD" mark. At that moment, the first two digits "12" flash.

"▲" mark can be moved by **FUNCTION** button.

- 3 Push the **+** or **-** button to set at "00" for all digits and then push the **SET** button. At that moment, display will stop flashing and the setting is now completed.

- 4 Push the **SETTING END** button to get out of the setting mode. Turn the key to "L" position. Make sure "date" and "time" are indicated on the display and "colon" is flashing. Then replace the cover.

6. PRINTING LIST OF SETTING INFORMATION

With this function, you can check following information.

List No.	Printing List
1.	Setting Information
2.	Program Settings

Note Total pages are not always 2 pages.



Make sure the key is locked ("L" position) before you go into this mode.

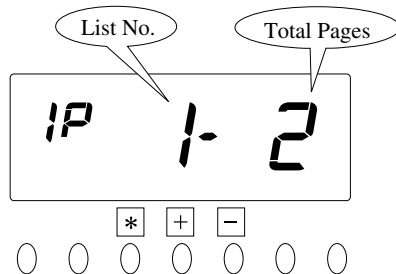

- 1 Push the and button for 3 seconds.
At that moment, "IP" is indicated on the left-side of display.

Printing list of "Setting Information".

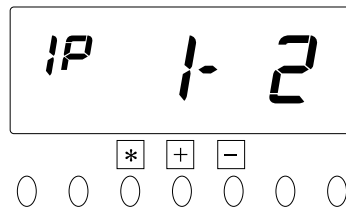

Make sure "List No." is "1" before inserting a time card.

Insert a blank time card and a list is printed out.

You can go on "Printing list of program settings".
If you don't need it, go on step 2.

Printing list of "Program Settings".



"Program settings" is available only if you set weekly programs.
Refer to "Setting the Weekly Program".

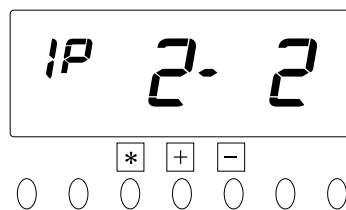

Push the or button to set "List No." at "2". Then, insert a blank time card and a list is printed out.

Note Pages may be added depends on the number of program settings.

Print Example

No	TIME	C-I-R-M	DOW
01	12:00	6-1-0-0	S-----S
02	09:00	2-1-1-1	-MTWTF-
03	17:00	4-2-0-0	-MTWTF-

Number of 3 program

C: Column
I: Irregular
R: Relay
M: Melody

S: Sunday M: Monday
T: Tuesday W: Wednesday
T: Thursday F: Friday
S: Saturday

"0" means "--".

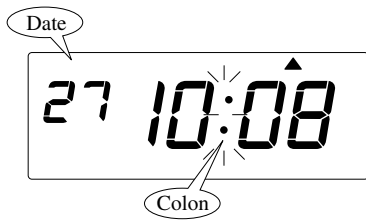



- 2 Push the **SETTING END** button to get out of the setting information mode. Make sure "date" and "time" are indicated on the display and "colon" is flashing. Then replace the cover.

7. RESETTING

Note All settings will be deleted and will revert to the factory defaults when the reset switch is pushed.

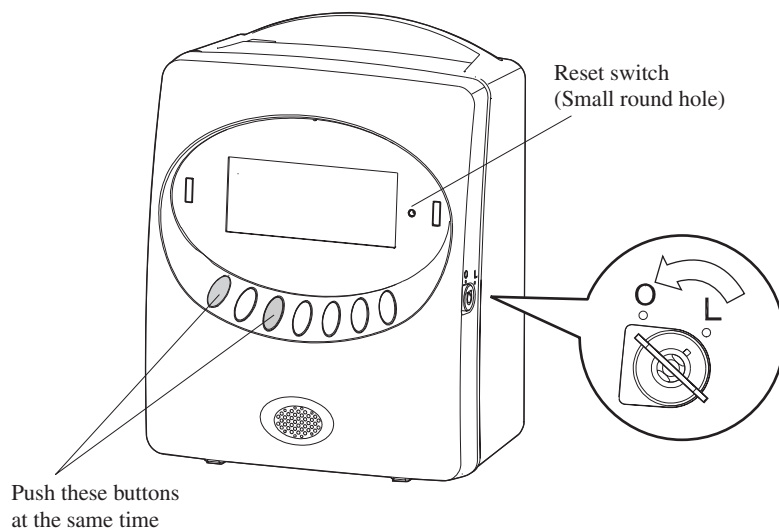
 To make new settings, please refer to "5. SETTINGS".



 Make sure the key is open ("O" position) before resetting.

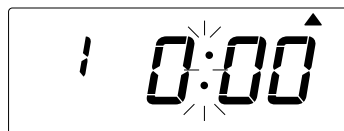
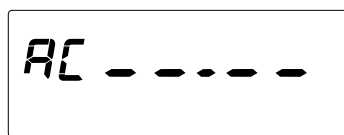

1 Remove the cover.
Push the reset switch with a pointed implement while pushing the **DATE/TIME** and ***** button.

2 At that moment, the display will change to AC "----".
And after a few seconds, the display will be as shown in the left figure.

Only for V/VN Card Users Card Resetting

QR-6560

This function is available if you select "1: V/VN Card" in the "Card Type" setting.

Example The number of the card you want to reset is "003".

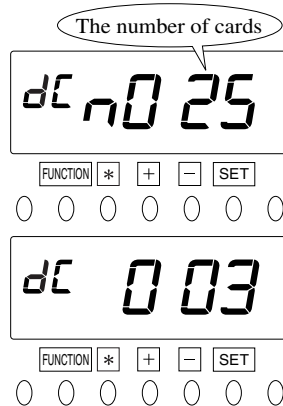

1 Push the reset switch with a pointed implement while pushing the **FUNCTION** and ***** button. Then, the number of cards that you are using will be shown on display.

2 Select the desired number by pushing the **+** or **-** button. In case of the example, push the **+** button to set at "003" and then, push the **SET** button. At that moment, the display will stop flashing, and push the **SET** button once more.

Point The desired number can be also reset by inserting the correspondent card.

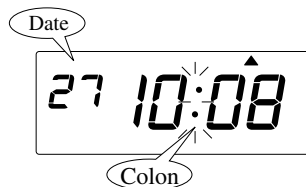

3 Now the setting is completed. Make sure "date" and "time" are indicated on the display and the "colon" is flashing. Then replace the cover.

All Cards Resetting

When you want to reset all cards manually

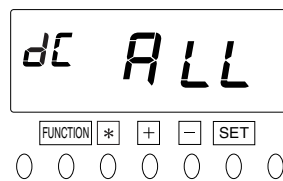

1 Refer to the Step 1 in "Card Resetting".

2 Push the **+** or **-** button to show "ALL" and then push the **SET** button. At that moment, the display will stop flashing, and push the **SET** button once more.

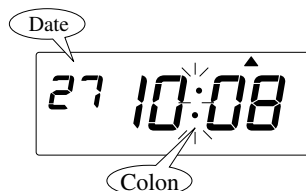

3 Now the setting is completed. Make sure "date" and "time" are indicated on the display and the "colon" is flashing. Then replace the cover.

8. MOUNTING UNIT ON WALL

The unit can be mounted on a wall using the supplied mounting fittings. To mount the unit on a wall, take the following steps:

- 1 Install the supplied long screws into a wall 3.94 inches (10 cm) apart. Be sure to keep about 0.12 inches (3 mm) of the screw head out of the wall.

! The supplied screws are intended for use on a thick wooden wall or wooden column. Do not use them on any other materials. There is a danger that the unit may come off if used on the other materials.

Point Please use the template attached to the last page of this manual.

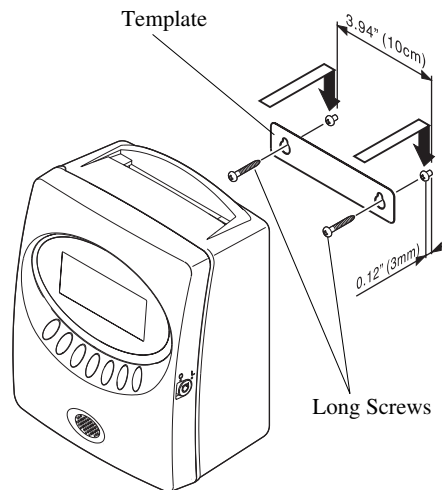

- 2 Mount the supplied brackets into the clock with the short screws and into the wall with the long screws as shown in the right figure.

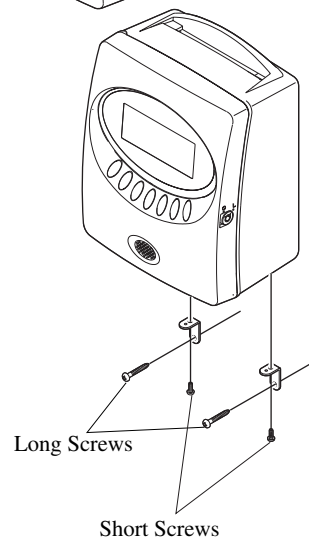

9. INSTALLING THE OPTIONAL BATTERY BACK-UP

This option allows for printing without AC power.

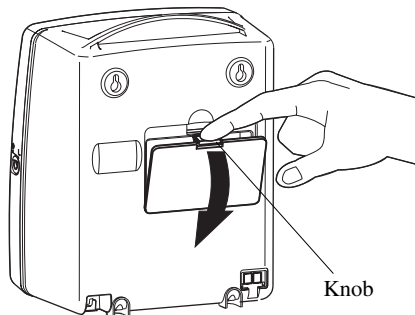

- 1 Remove the cover of the battery compartment on the back of the unit by pushing the knob and then pull it toward you.

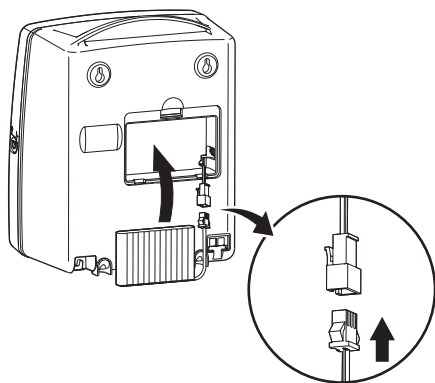

- 2 Position the battery as shown in the figure on the left.

! The connector cord should be on the right side.

- 3 Connect the connector. Tuck away the connector cord into the open space in the compartment.

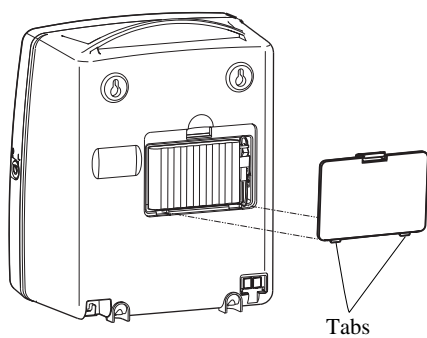

- 4 Replace the cover into the slot as shown on the left. At that time make sure to fit the tabs at the bottom of the cover.

! Make sure the cord is not caught when closing the Cover.

10. CONNECTING EXTERNAL TIME SIGNAL

QR-6560

When a signal is activated the internal contacts close completing the circuit. These internal contacts are "dry" and supply no voltage. Voltage applied to these contacts must not exceed 30 volts.

Connection Specifications for External Time Signal Contact

- Contact output: dry contact
- Contact capacity:
30V, 2A or less (Resistive)

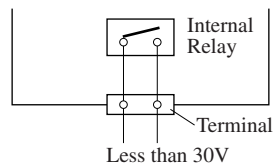

CAUTION:

Disconnect the QR-6560 from AC power before connecting.
Improper connection may cause a malfunction of the unit.

Insert wires into two terminals for external time signal relay while pushing the button with a pointed implement.

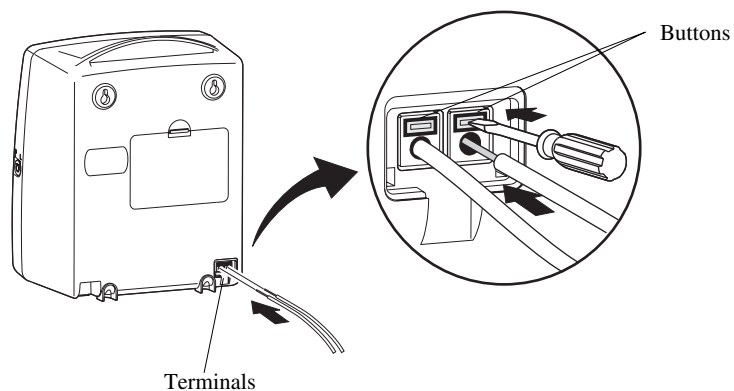

Anschluss-Schema für Externes Signal

QR-6560

Sofern ein Signal aktiviert wird, schliesst der Relais-Kontakt. Hierbei handelt es sich um einen spannungsfreien Kontakt. Die zugeführte Spannung darf 30 Volt nicht uebersteigen.

Anschluss-Spezifikation fuer den Signal-Relaiskontakt

Kontakt-Ausgang: Spannungsfrei

Kontakt-Last: 30 V, 2A max. (Ohmsche Last)

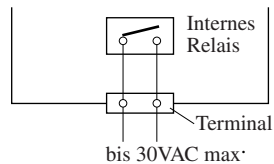

Vorsicht:

Den Eingangs-Spannungsstecker ziehen bevor Arbeiten am Relaisanschluss erfolgen. Fehlerhafter Anschluss kann zu Defekten an der QR-6560 führen.

Gemaess Abbildung den oberen Teil der Klemme mit einem Schraubenzieher druecken. Fuehre die Draehnte einzeln ein.

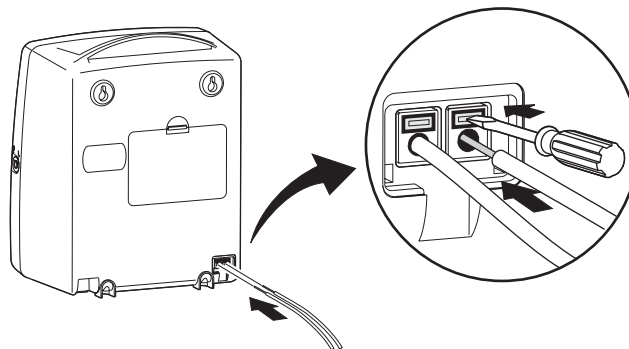

11. TROUBLESHOOTING

Error No. appears

No.	Error contents	Action
E-00	CPU error.	Contact the store from whom you bought the unit.
E-01	The remaining life of lithium battery for memory back-up is short.	
E-03	The front and back of the time card inserted is wrong.	Correctly insert the time card.
E-04	Inserted time card was wrong type.	Insert a correct type of card.
E-05	The card is not pulled in properly.	Make sure that another time card is not jamming in the time recorder. Try to insert the time card again.
E-10	RAM error.	Contact the store from whom you bought the unit.
E-12	Clock will not work.	
E-15	Card sensor error.	Make sure that another time card is not jamming in the time recorder and the ribbon cassette is correctly inserted in place.
E-30	Printing cannot be performed. The printer motor or sensor is not normal.	After making sure of the above, close the cover.
E-35	Inserted time card was wrong type. The card is stuck in the time recorder.	In case the card is completely stuck in the unit and does not come out, open the front case and remove a ribbon cassette first. Then, slide the card downwards and take it off from the button of the unit. Also check whether the correct card type is selected.
E-38	Printing cannot be performed. The printer motor is not normal.	Make sure that another time card is not jamming in the time recorder and the ribbon cassette is correctly inserted in place. After making sure of the above, close the cover.
E-40	Password error.	Input the correct password you set. (4-digit numbers)
E-41	The start date and the end date of the daylight saving time are the same date.	Correctly set the daylight saving time.
E-49	Input the wrong figures.	Check the setting contents and input the correct figures.
E-50	Can't use the time card. (QR-6560)	Check the barcode area whether it is smudged or damaged.
E-51	Punch error (punch time error). (QR-6560)	Check whether the time was turned back or not. Also check whether the card was inserted within 1 minute after the last punch.
E-52	Punch error (punch logic error). (QR-6560)	Check whether the day's 6th column was already used. Also check whether you can print if you change a time card or the day changes.

*If the error number is still displayed, contact the store from whom you bought the unit.

Other failures

- **The unit does not operate.**

Check whether the power cord is properly in an AC outlet.

- **The unit does not print.**

Check whether the ribbon is installed in place.

- **Print is not located in the right place.**

Check whether the setting of the pay period ending date is set correctly.

Check whether the day advance time is set correctly.

Make sure that no part of the time card is folded, and that the time card is inserted straight into the unit.

→ If improper printing still remains after checking above points, contact the store from whom you bought the unit.

- When the flat cable connected to the print head comes off, please set the cable as shown in the following figure.

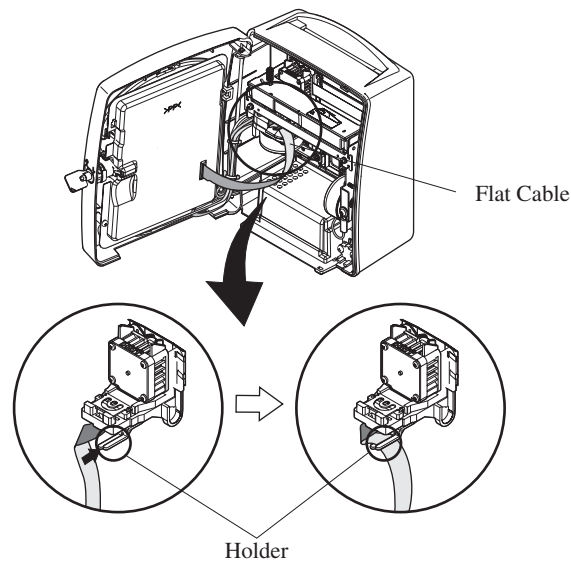

12. SPECIFICATIONS

Clock accuracy	Monthly accuracy ± 15 sec. (at ordinary temperatures)
Calendar	Year up to 2099. Automatically adjusted to leap years, 31-day months and months with thirty or fewer days, and the days of the week.
Printing system	Dot matrix imprint
Power failure Compensation	Three years of cumulative power failure hours after the date of shipment.
Print at power failure	Optional battery, 100-times printing or 24hours (option)
Connection of external time signal	Connection with an External Alarm device (QR-6560) (No voltage signal output)
Operating environment	Temperature: -5°C to $+45^{\circ}\text{C}$: $+23^{\circ}\text{F}$ to $+113^{\circ}\text{F}$ Humidity: 20% to 80%RH, no condensation The unit operates normally at temperatures of 5°C or below, but the print density, reaction of the liquid crystal display, and the number of prints at power failure are inferior to those at normal temperature operation.
Dimensions	6.77" (w) x 8.58" (h) x 4.8" (d) 172 (w) x 218 (h) x 122 (d) mm
Weight	Approx. 4.2 lbs. (1.9kg)
Rating	220-240VAC 50/60Hz 0.2A

Spezifikation

Uhr-Genauigkeit	Monatliche Abweichung ± 15 sec. (normale Umgebungstemperatur)
Kalender	bis zum Jahr 2099, automatische Erkennung der Monatslaenge, Monatstage und Schaltjahr
Drucksystem	Nadeldrucker
Datenerhalt bei Spannungsfehler	3 Jahre nach Spannungsausfall
Nonstromversorgung (Option)	Gangreserve für ca. 24 Std. oder 100 Registrierungen.
Externes Signal	Anschluss eines externen Signalgebers (QR-6560) (Kontakt-Ausgang: Spannungsfrei)
Funktionsumgebungs- Bedingungen	Temperatur: -5°C bis $+45^{\circ}\text{C}$: $+23^{\circ}\text{F}$ bis $+113^{\circ}\text{F}$ 20% bis 80% rel. Luftfeuchte, nicht kondensierend Das Gerät funktioniert auch unter $+5^{\circ}\text{C}$ jedoch kann die Druckintensität und die Reaktionsstärke des LCD geringer sein, ebenso die Menge der Druckzyklen bei Betrieb mit optionaler Batterie.
Masse	172 (B) x 218 (H) x 122 (T) mm
Gewicht	ca. 1,9 kg
Spannungsversorgung	220-240VAC 0,2A 50/60Hz

13. TIME CARD SPECIFICATIONS

(1) V / VN Card

Monthly, both sides, with barcode

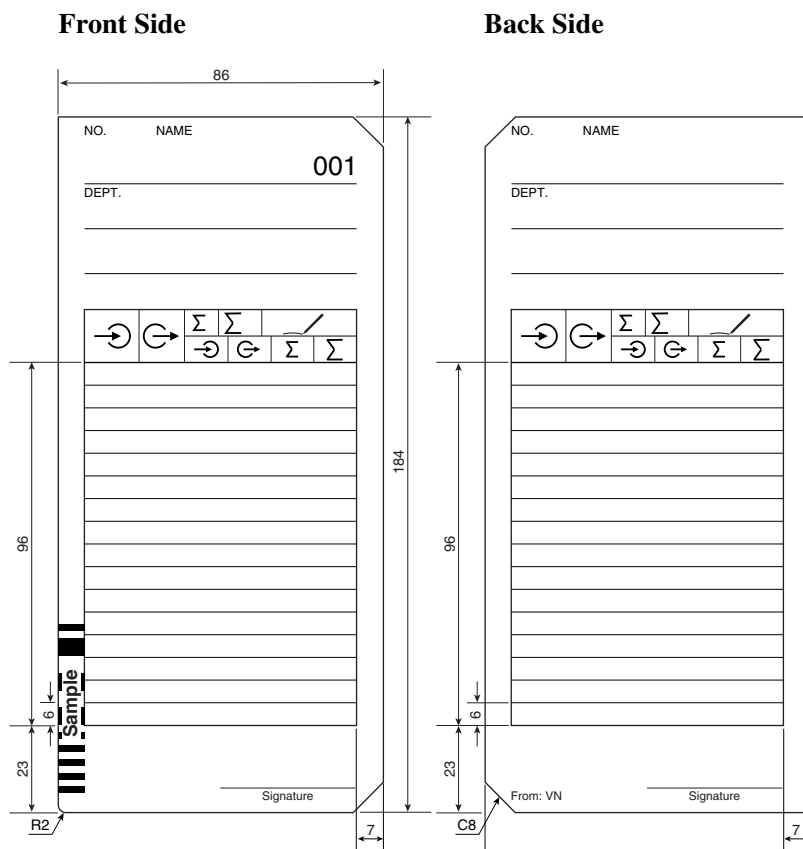

Unit: mm

(2) S Card
 Monthly, both sides

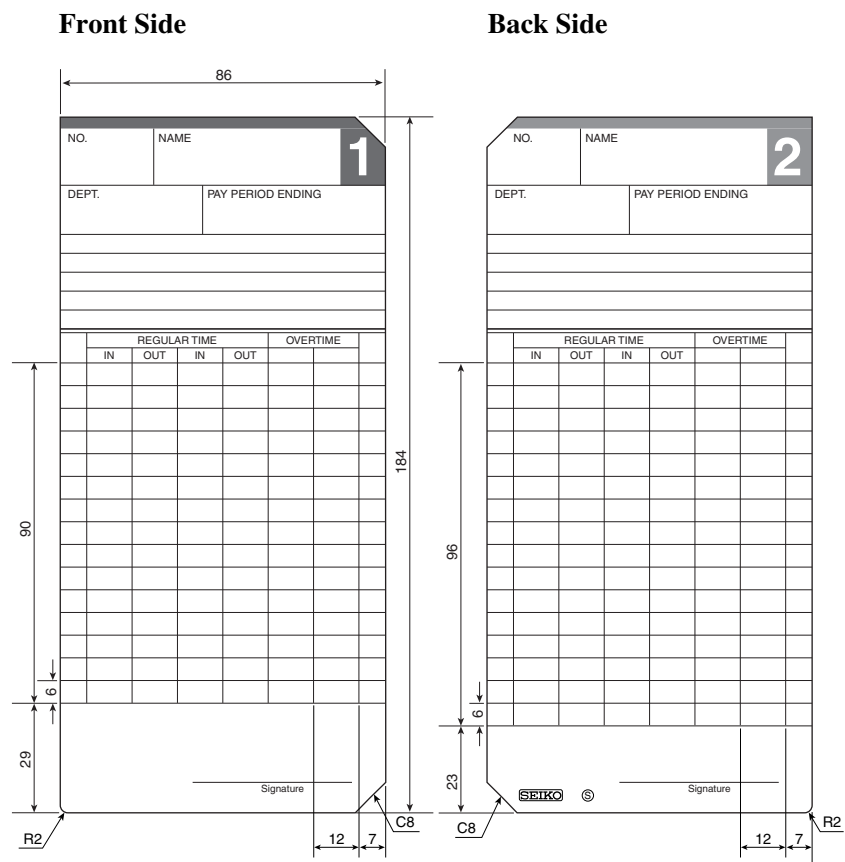

Unit: mm

Note

Recommended Paper Thickness : 0.45 ± 0.05mm

(3) Weekly Card
Weekly, one side

(4) Bi-Weekly Card
Bi-weekly, one side

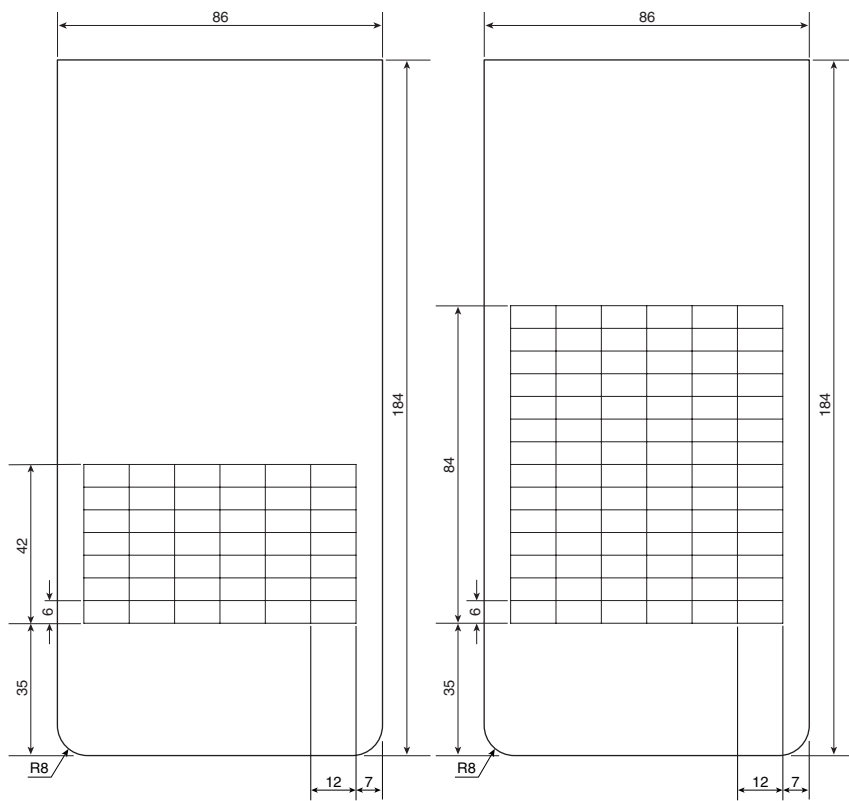

Unit: mm

Note

Recommended Paper Thickness : 0.45 ± 0.05 mm

(5) Other A Card
 Monthly, both sides

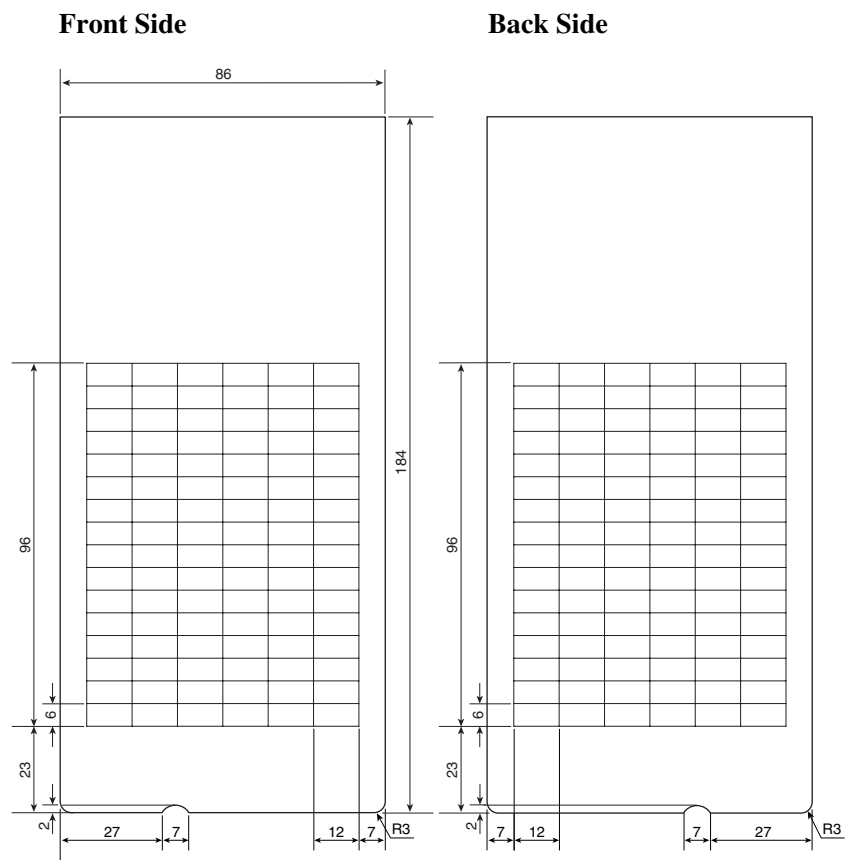

Unit: mm

Note

Recommended Paper Thickness : 0.45 ± 0.05 mm

(6) Other B Card

Monthly, both sides

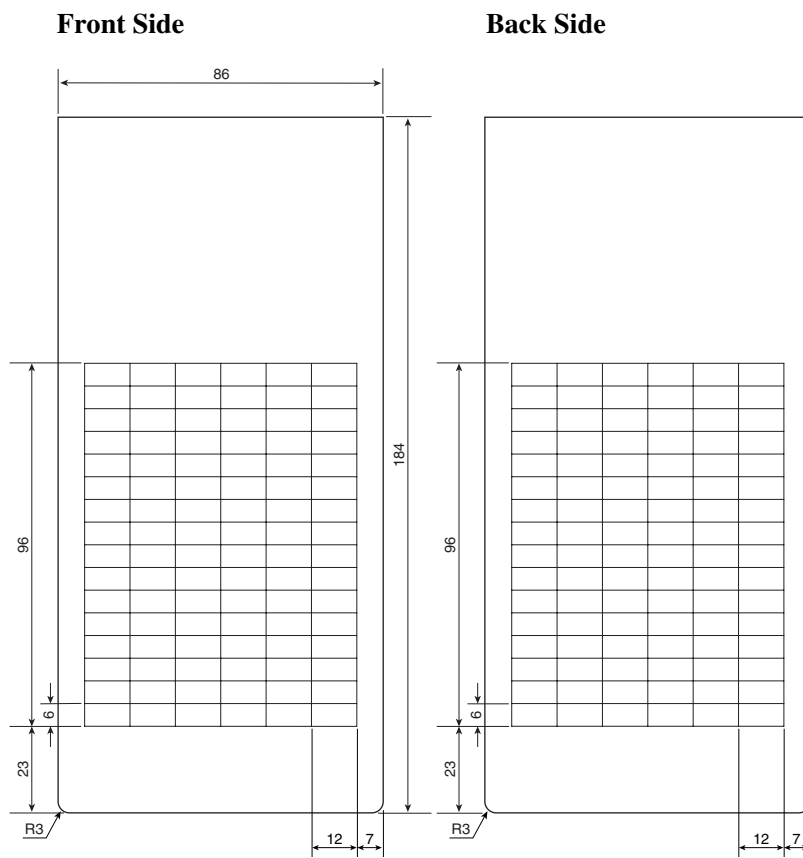

Unit: mm

Note

Recommended Paper Thickness : 0.45 ± 0.05 mm

Template for wall mounting

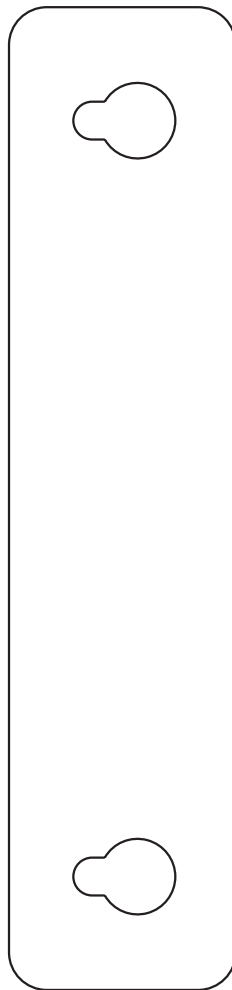

SEIKO PRECISION INC.

ALL RIGHTS RESERVED
© 2006 SEIKO PRECISION INC.

Q0310-61201